

estudiobola  catálogo
2019



Desenho autoral, simplicidade formal e elegância a todo custo. Esta frase é a espinha dorsal do trabalho de dois arquitetos paulistas formados pela Universidade Mackenzie. Flavio Borsato e Mauricio Lamosa estudaram juntos e fundaram o estudiobola há dezesseis anos em torno deste conceito, criando produtos com personalidade e simplicidade estudada à exaustão.

Um trabalho isento de modismos e tendências requer uma pesquisa rigorosa de proporções e acabamentos a fim de conferir às criações resultados atemporais, que elevam a vida útil das peças, deixando-as agradáveis aos olhos durante anos. Esse conceito é aplicado em toda produção do estudiobola, desde a criação de uma cadeira até projetos de luminárias.

Alguns prêmios de design durante esse trajeto, como o Prêmio Museu da Casa Brasileira, ajudaram a balizar o trabalho da dupla que é reconhecida no segmento moveleiro pela excelência do seu desenho e por sempre vincular seu trabalho à busca de resultados comerciais contundentes, sedimentando relações com as empresas que produzem e revendem suas criações.

A estrutura interna cresceu durante os anos sem perder o diferencial que os fez chegar até aqui, um atendimento objetivo, sincero e profissional. A figura da dupla de criação deu lugar à um time competente de profissionais que ajudam a colocar a empresa e seus produtos nas melhores e mais conceituadas lojas de mobiliário e decoração do país, além de participar constantemente em conceituadas publicações nacionais e internacionais do segmento.

Atualmente o estudiobola vislumbra outros horizontes e desafios e divide toda sua expertise em design com o consumidor em seu próprio local de trabalho. Um galpão de uma antiga fábrica abriga a loja de móveis para uso interno e externo, luminárias, fotografias e revestimentos com desenho exclusivo e diferenciado.

Um espaço que vale a pena ser visitado pelo conceito industrial de exposição, mas principalmente para ser atendido pelos designers e se deparar com todo esse histórico aplicado em seus produtos.

intro



clientes

estudiobola 

projetos



estudiobola 

studiomk27



estudiobola 

paranoid

poltronas
sofás
cadeiras
mesas de jantar
bancos
banquetas
buffets
homes
mesas laterais
mesas de centro

estantes
aparadores
gaveteiros
camas
espelhos
luminárias
cerâmicas
tapetes
complementos
área externa



elevação lateral

elevação frontal

74

70

82

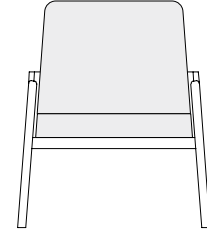
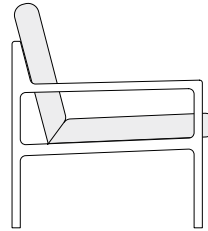

74

140

82

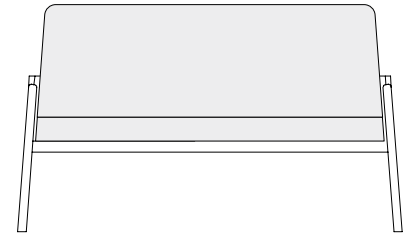
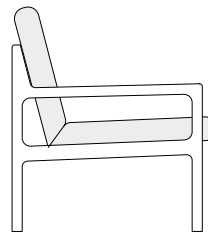

allegro

poltrona



elevação
frontal

70

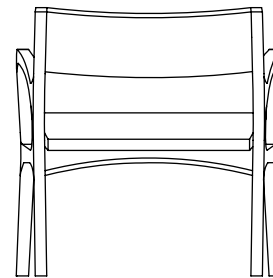

71

elevação
lateral

76

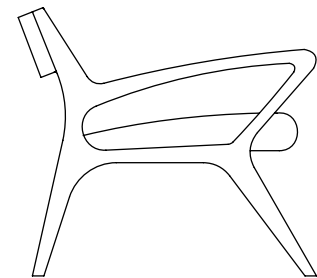



beppi
poltrona

elevação
frontal

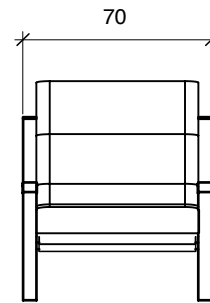

elevação
lateral

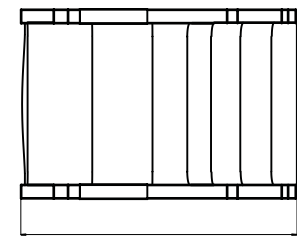
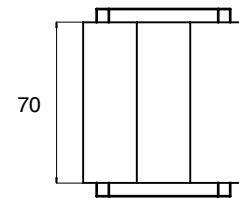
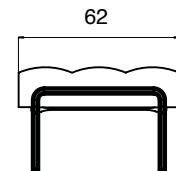
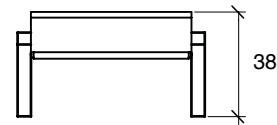
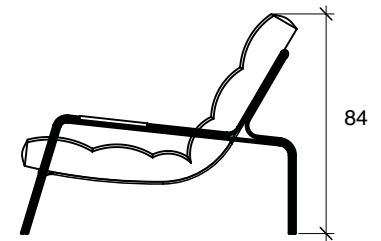

elevação
superior



ester

poltrona

elevação
lateral

81

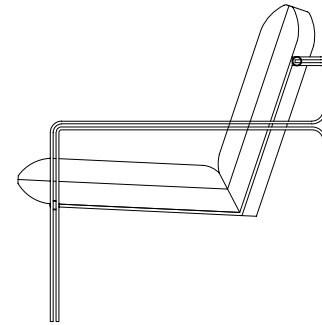

80

elevação
frontal

68

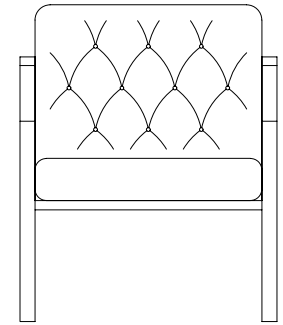



fat
poltrona

elevação
frontal

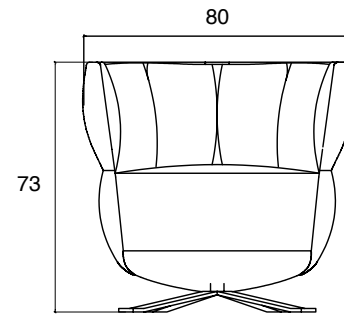

elevação
lateral

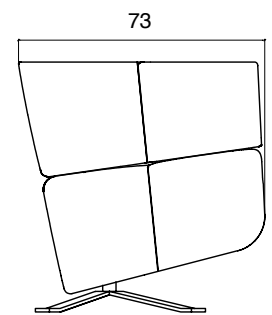

elevação
superior

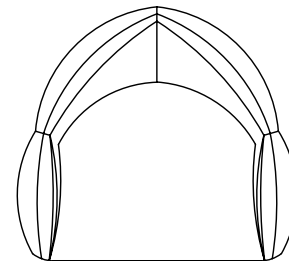



helga

poltrona

elevação lateral

elevação frontal

60

60

74

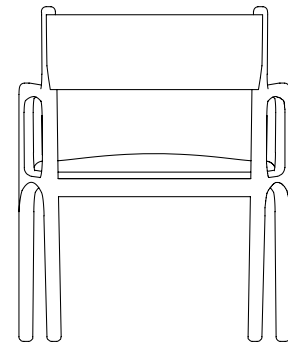
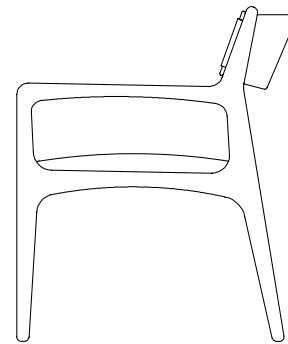



less
poltrona

elevação
frontal

120

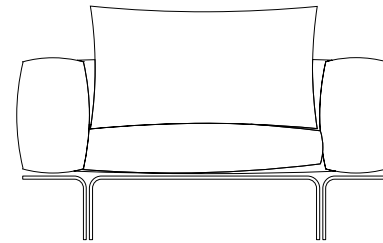

79

elevação
lateral

100

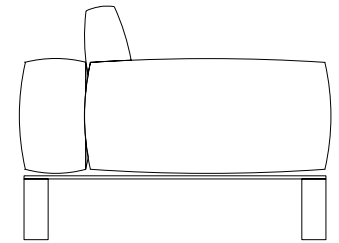



luisa

poltrona

elevação
frontal

71

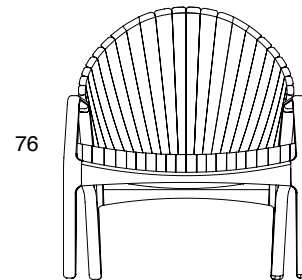

elevação
lateral

70

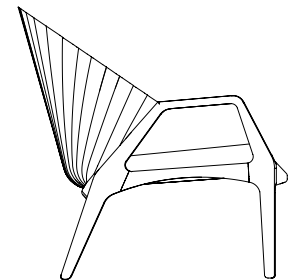

elevação
superior

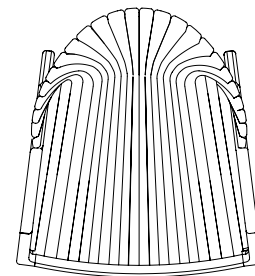



mabelle

poltrona

elevação
frontal

elevação
lateral

80

83

80

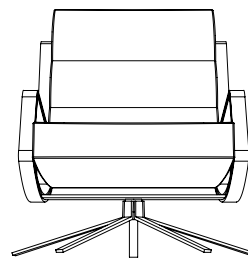

52

37

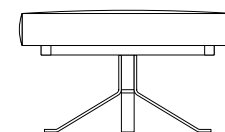
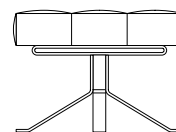

66

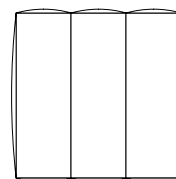

elevação
superior



malu
poltrona

elevação
frontal

71

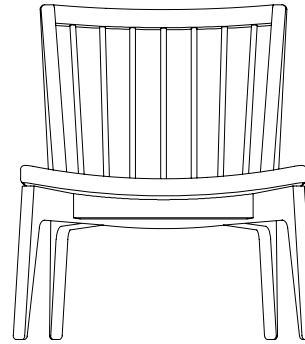

84

elevação
lateral

84



elevação
superior

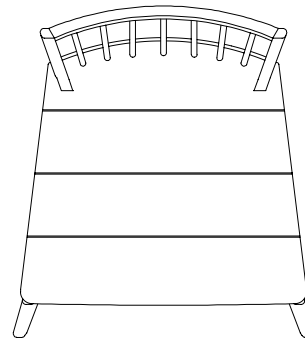

shell

poltrona



elevação
frontal

112

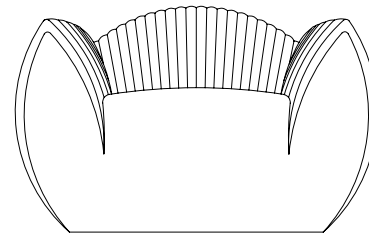

70

elevação
lateral

100

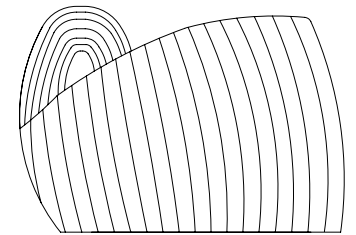



sottile
poltrona

elevação
frontal

71

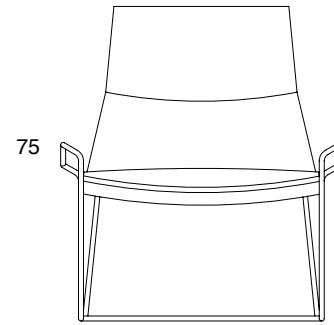

elevação
lateral

61

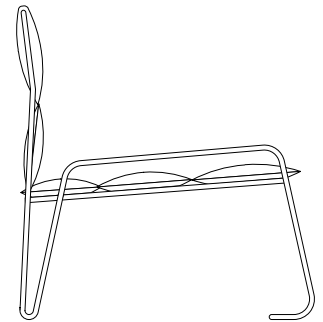

61

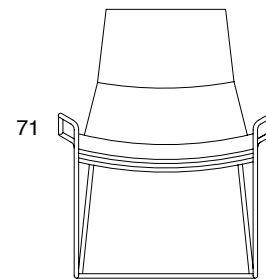

56

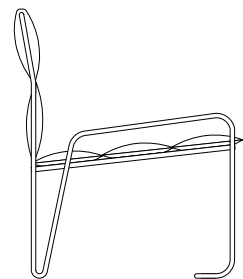

sottile chaise

poltrona



elevação
frontal

68



88

elevação
lateral

140

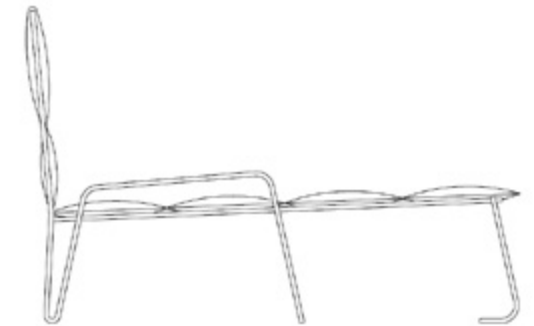

volpi
poltrona



elevação
frontal

92

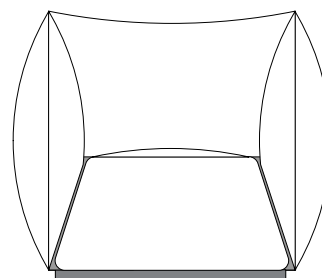

83

elevação
lateral

92

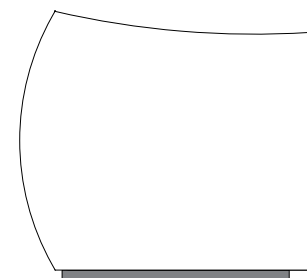



biron
sofá

elevação lateral

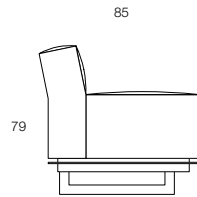

elevação frontal

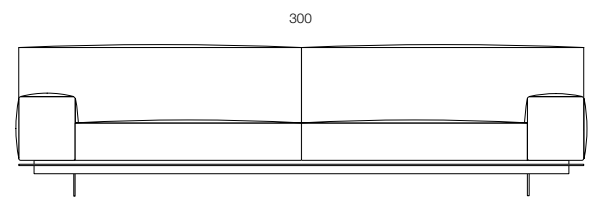
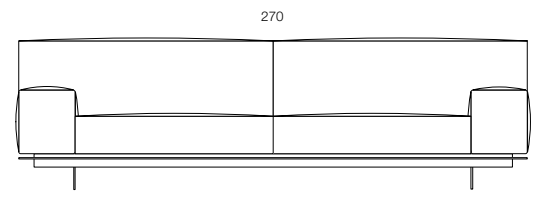
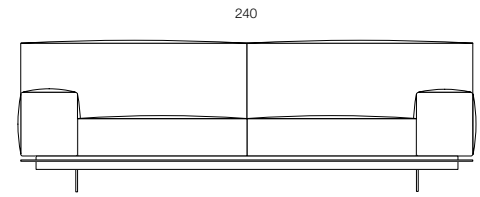
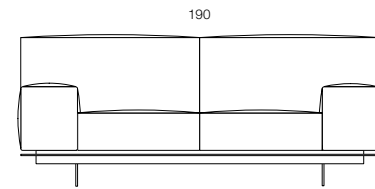



chantal

sofá

elevação
frontal

90

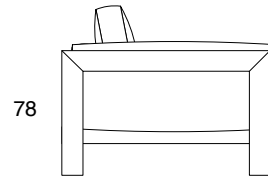

elevação
lateral

190 / 240 / 270 / 300

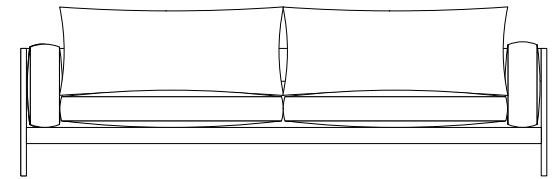

drops

sofá



elevação lateral

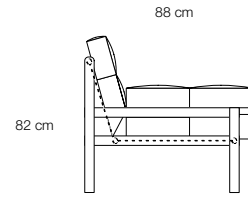

elevação frontal

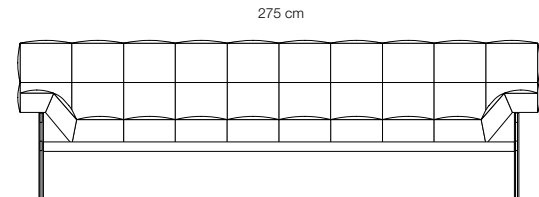
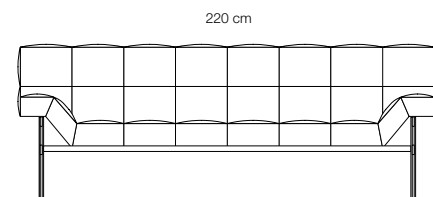
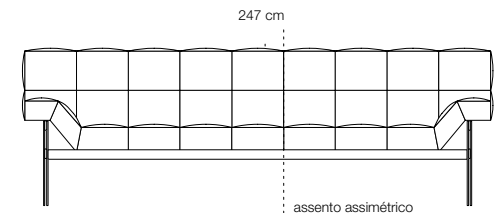
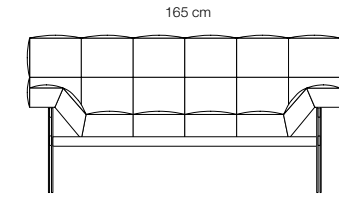



fillet
sofá

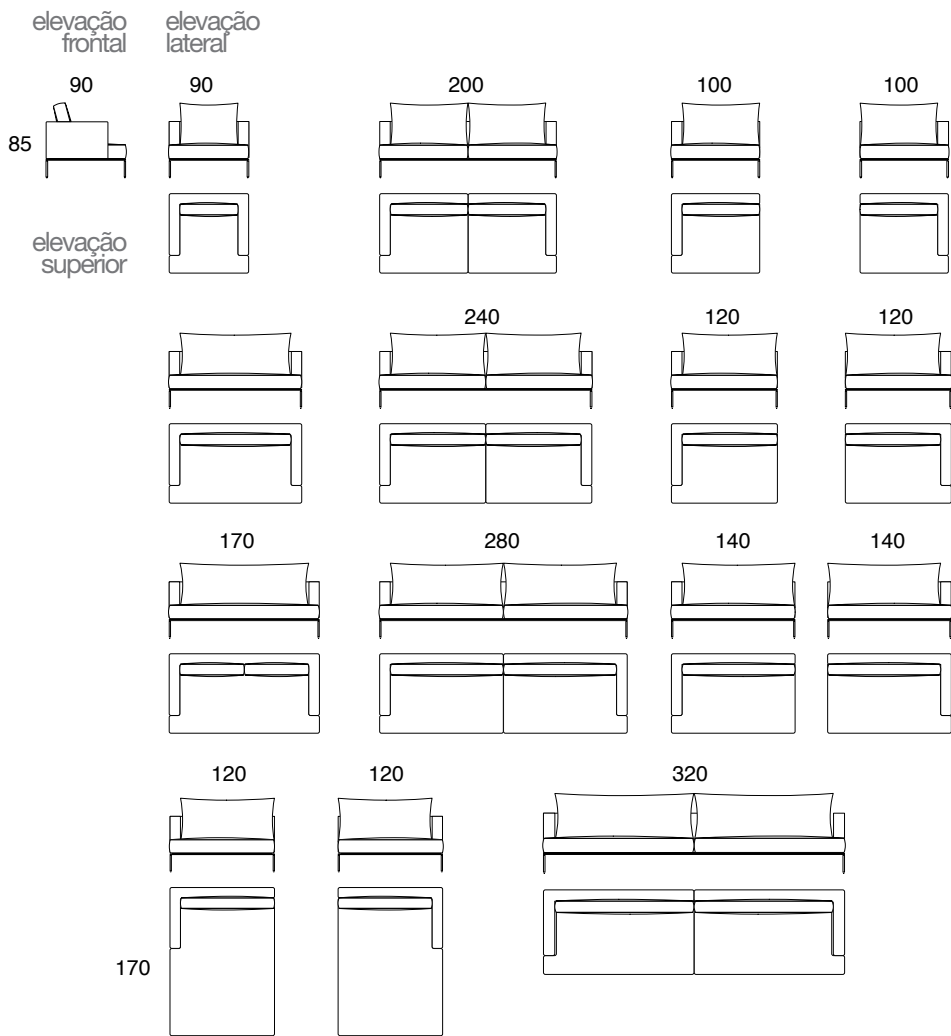



joy
sofá

elevação superior

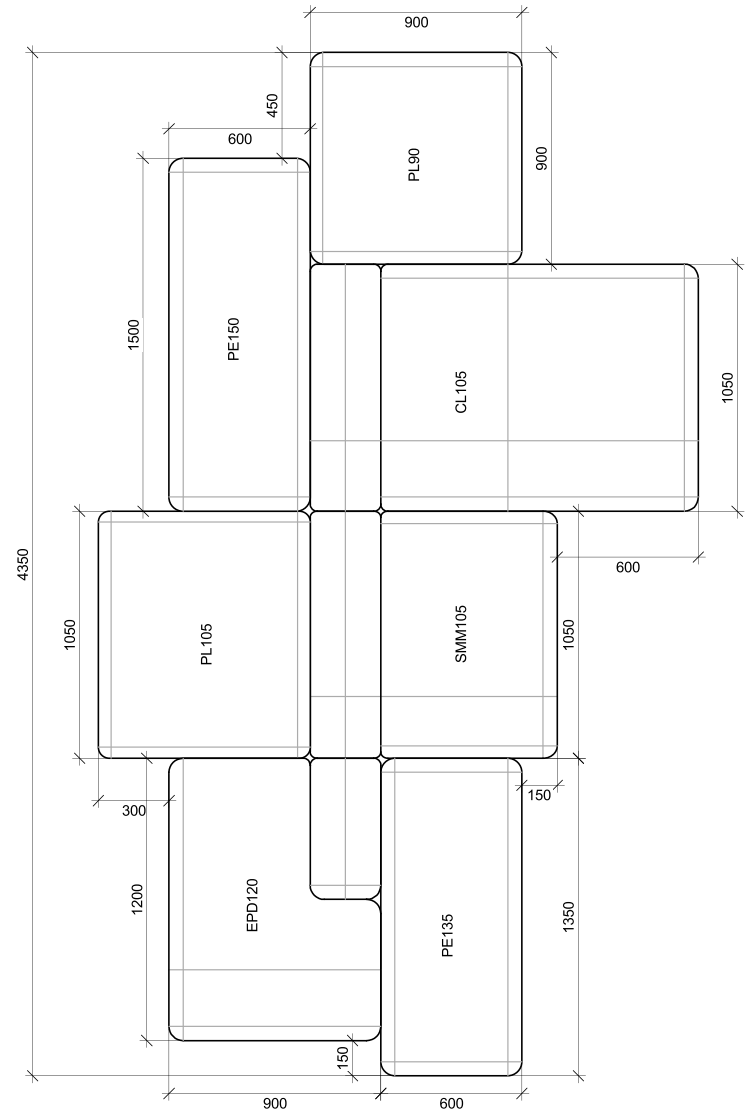

SUPER MÓDULOS

PROFUNDIDADE TOTAL DE 105 cm

PROFUNDIDADE TOTAL DE 90 cm														SUPER MÓDULOS PROFUNDIDADE TOTAL DE 105 cm		
CHAISE ESQ.	CHAISE	CANTO ESQ.	MEIO ENCOSTO ESQ.	BRAÇO ESQ.	MEIO M090	BRAÇO O DIR.	MEIO ENCOSTO DIR.	CANTO O DIR.	CHAISE DIR.	PUFFE LARGO PL090	PUFFE ESTREITO PE090 prof. 60 cm	SUPER BRAÇO ESQ.	SUPER MEIO SMM090	SUPER BRAÇO DIR.		
	CL105 prof. 165 cm	CE105	EPE105	BE105	M105	BD105	EPD105	CD105	CLE120	PL105	PE105 prof. 60 cm	SMBE105	SMM105	SMBD105		
CLE120 prof. 165 cm	CL120 prof. 165 cm	CE120	EPE120	BE120	M120	BD120	EPD120	CD120	CLD135 prof. 165 cm	PL120	PE120 prof. 60 cm	SMBE120	SMM120	SMBD120		
CLE135 prof. 165 cm	CL135 prof. 165 cm	CE135	EPE135	BE135	M135	BD135	EPD135	CD135	CLD135 prof. 165 cm	PL135	PE135 prof. 60 cm	SMBE135	SMM135	SMBD135		
CLE135 prof. 180 cm	CLG135 prof. 180 cm	CE150	EPE150	BE150	M150	BD150	EPD150	CD150	CLDG135 prof. 180 cm	PL150	PE150 prof. 60 cm	SMBE150	SMM150	SMBD150		
										SJ165	SJ180					

composição divã

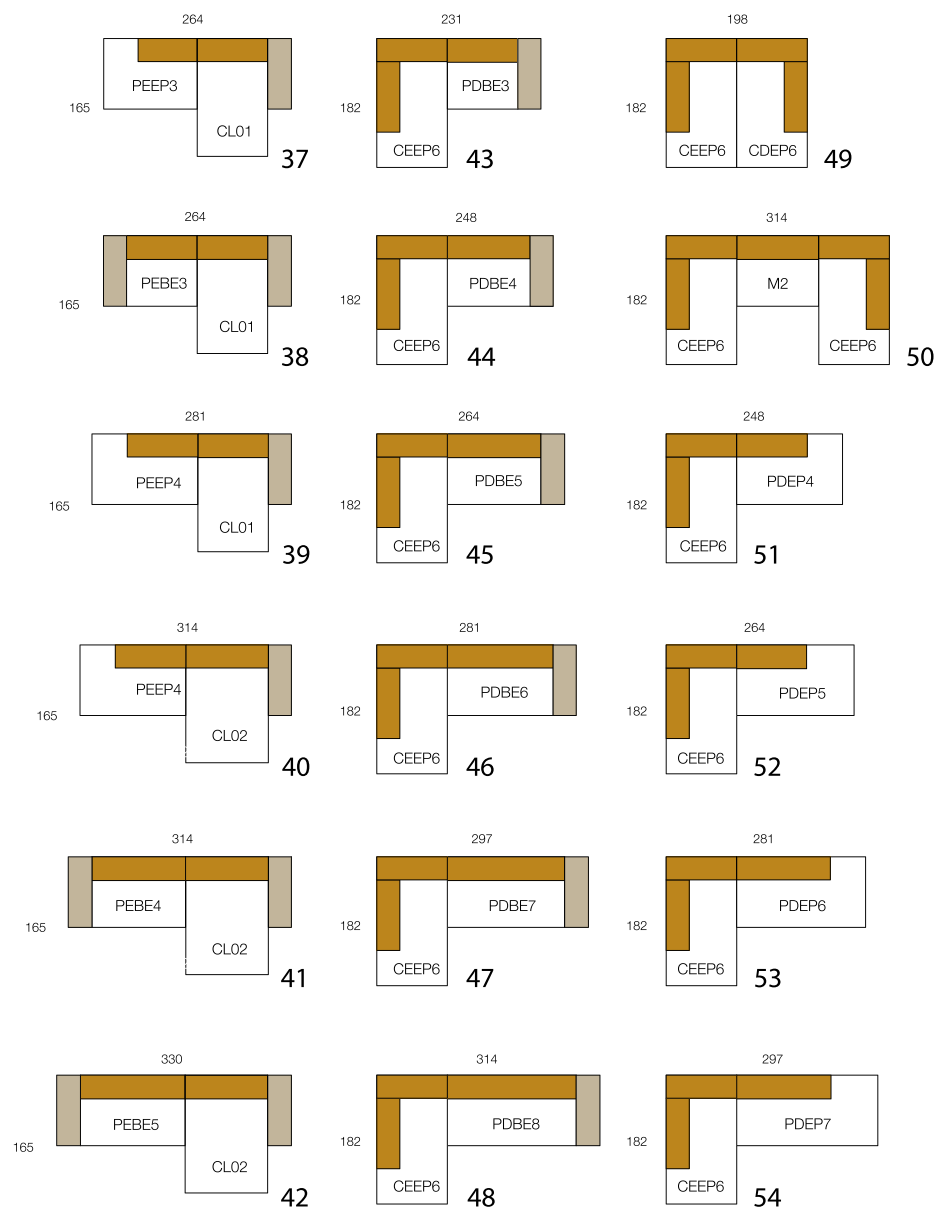

composição linear

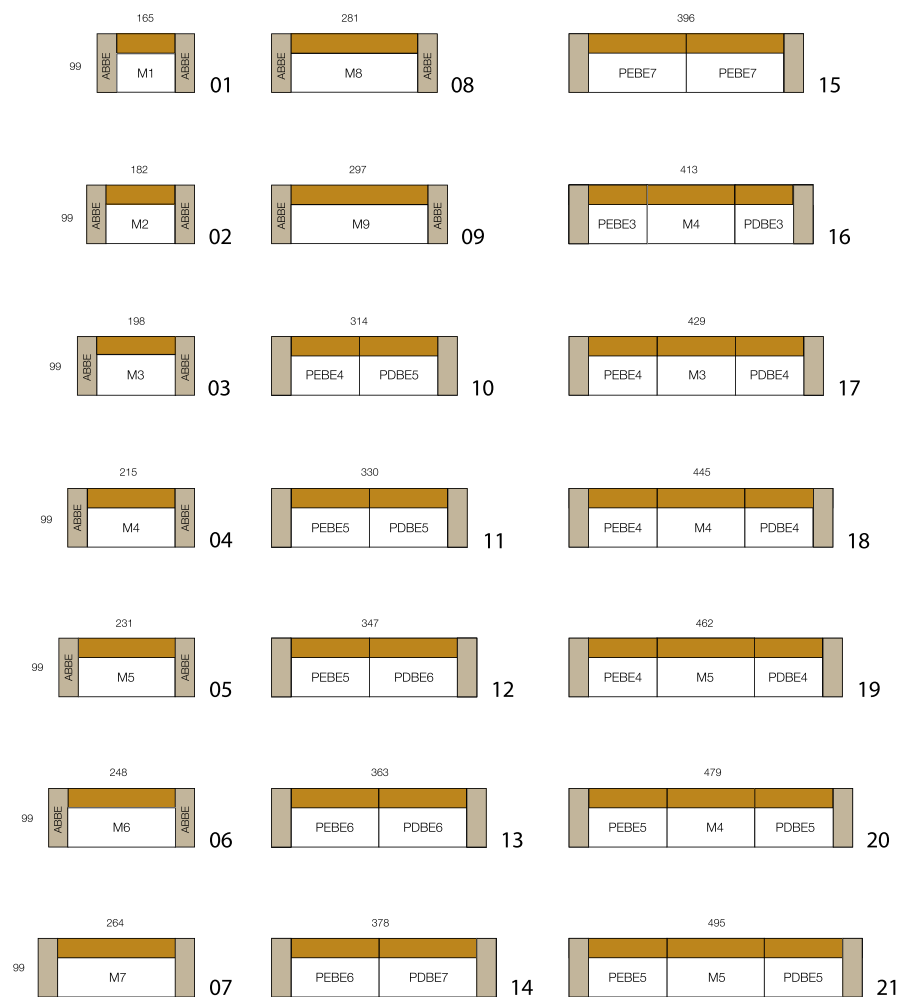

composição canto

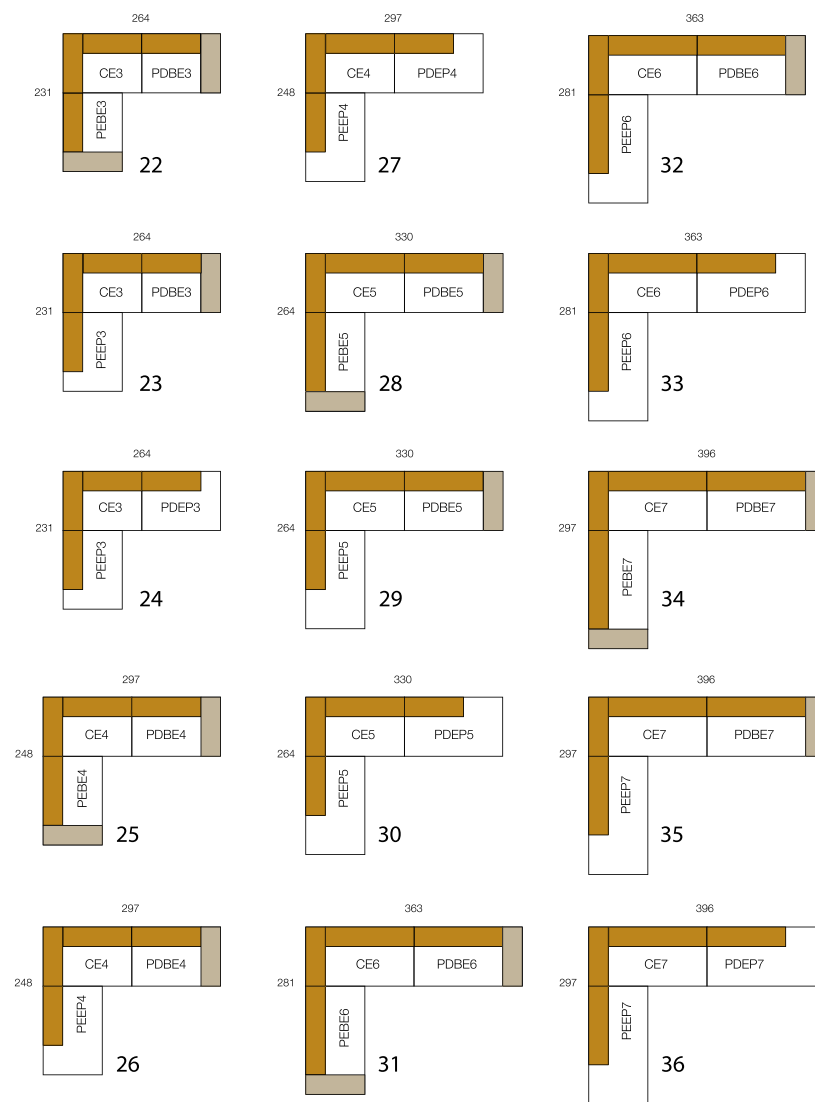

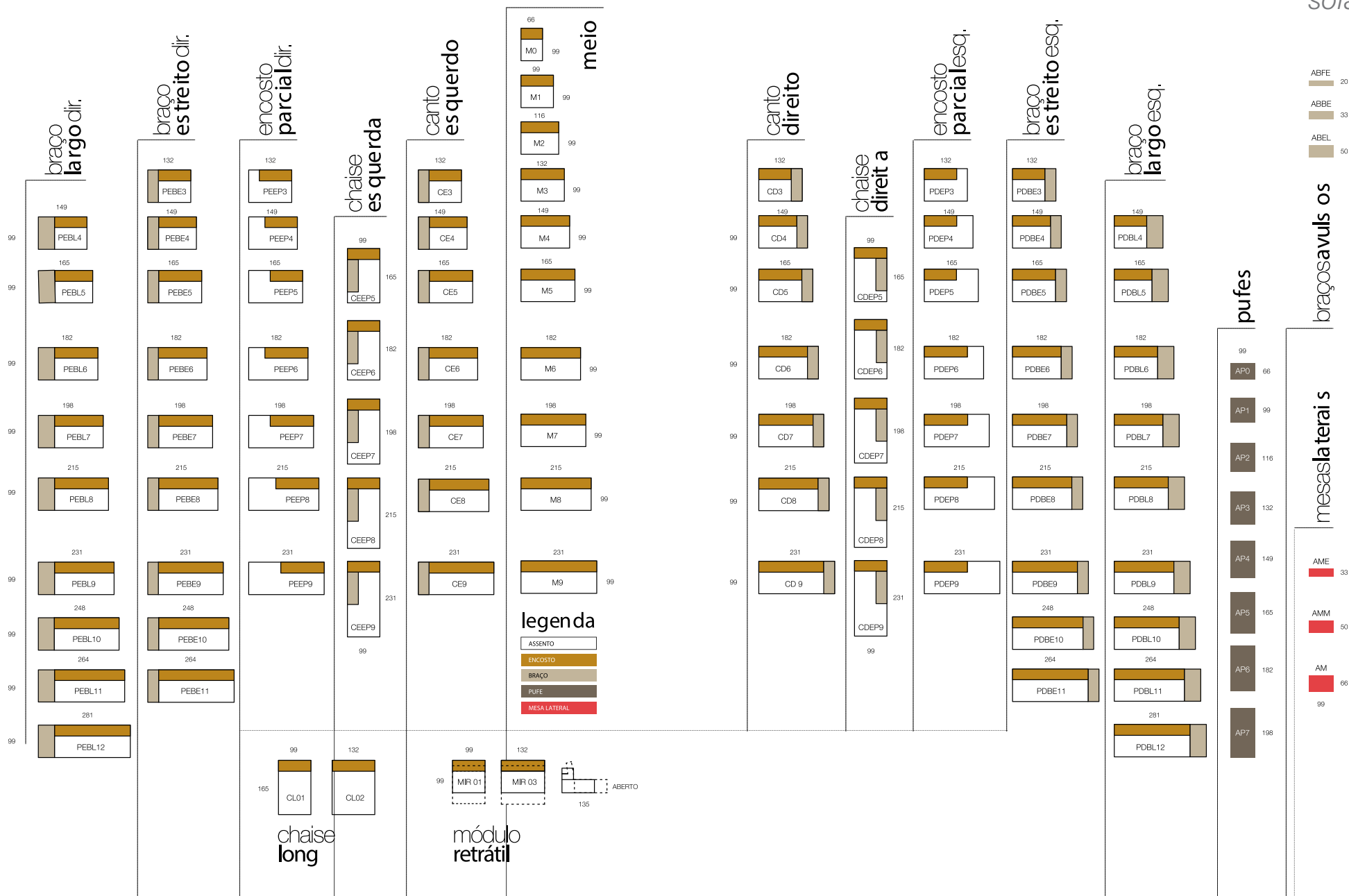



less
sofá

elevação
frontal

100

80

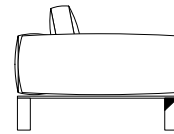

elevação
lateral

190 / 220 / 240 / 270 / 300

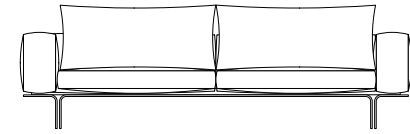





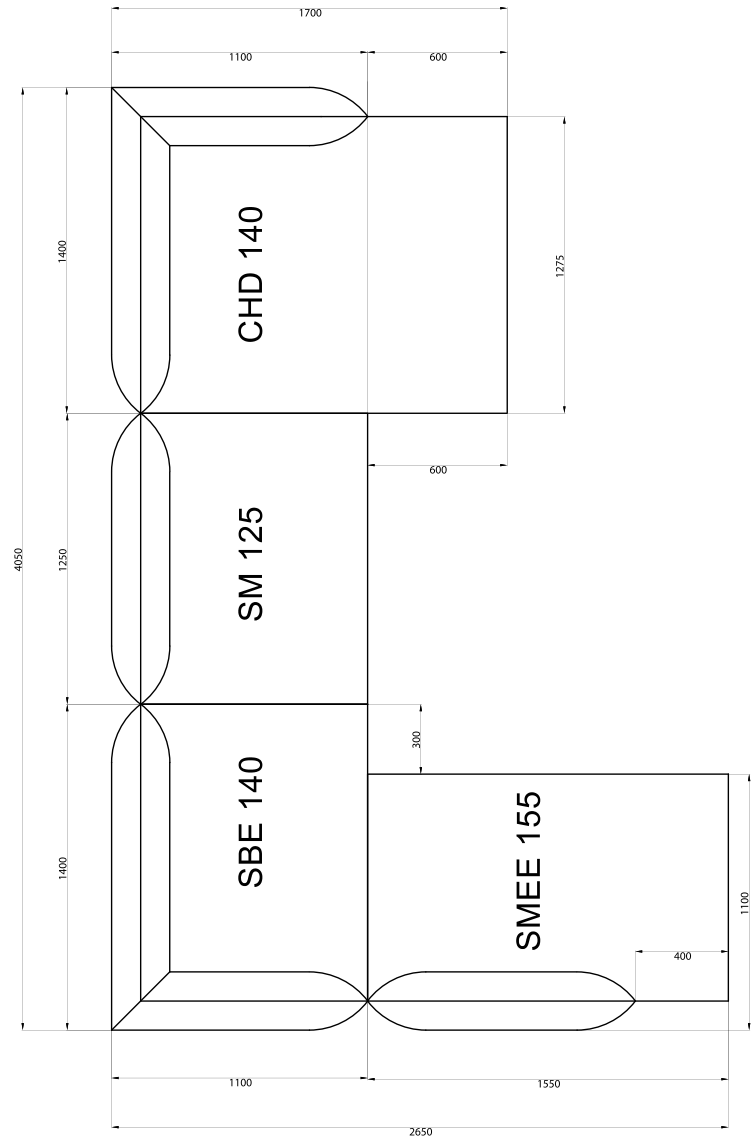







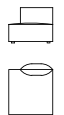
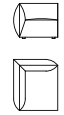
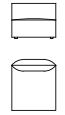
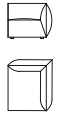
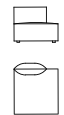
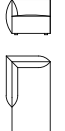
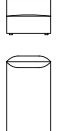
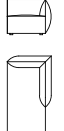

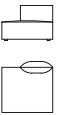
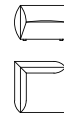
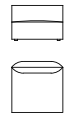
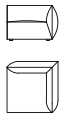
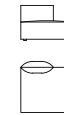

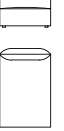
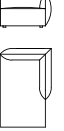

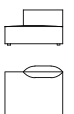
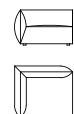
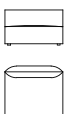

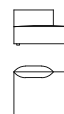
elevação superior

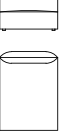
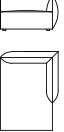

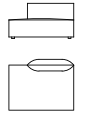
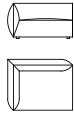
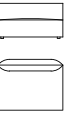
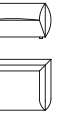
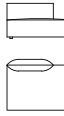
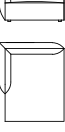
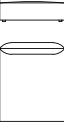
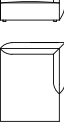
SUPER MÓDULOS
PROFUNDIDADE TOTAL DE 110 cm (85 útil)

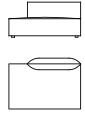
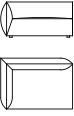
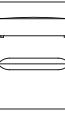
CHAISE
PROFUNDIDADE TOTAL
DE 170 cm (145 útil)

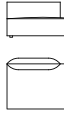
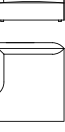
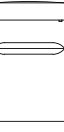
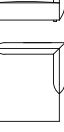
PUFFE

SUPER MEIO ENCOSTO ESQ.	SUPER BRAÇO ESQ.	SUPER MEIO	SUPER BRAÇO DIR.	SUPER MEIO ENCOSTO DIR.	CHAISE ESQ.	CHAISE MEIO	CHAISE DIR.	PUFFE LARGO PROF 90cm	PUFFE ESTREITO PROF 60 cm
SMEE 95 	SBE 95 	SM 95 	SBD 95 	SMED 95 	CHE 95 	M95 	CHD 95 	PL 95 	PE 95 
SMEE 110 	SBE 110 	SM 110 	SBD 110 	SMED 110 	CHE 110 	M110 	CHD 110 	PL 110 	PE 110 
SMEE 125 	SBE 125 	SM 125 	SBD 125 	SMED 125 	CHE 125 	M125 	CHD 125 	PL 125 	PE 125 
SMEE 140 	SBE 140 	SM 140 	SBD 140 	SMED 140 	CHE 140 	M140 	CHD 140 	PL 140 	PE 140 
SMEE 155 	SBE 155 	SM 155 	SBD 155 	SMED 155 	CHE 155 	M155 	CHD 155 	PL 155 	PE 155 



play
sofá

elevação
lateral

84 cm

73 cm

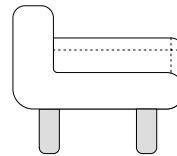

elevação
frontal

80 cm

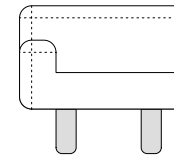

80 cm

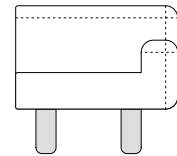

100 cm

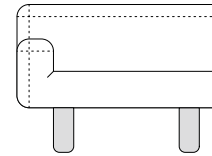

100 cm

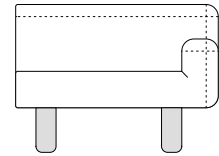

120 cm

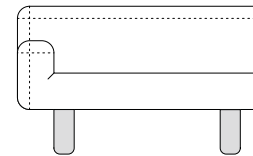

120 cm

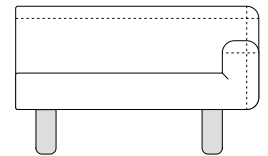

140 cm

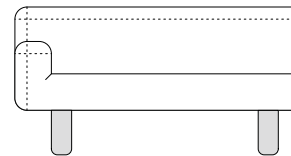

140 cm

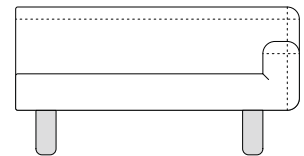

ELEVAÇÃO LATERAL

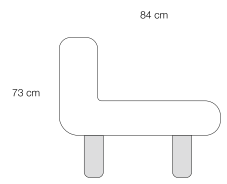

meio

ELEVAÇÃO FRONTAL

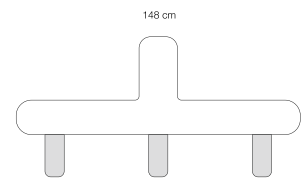
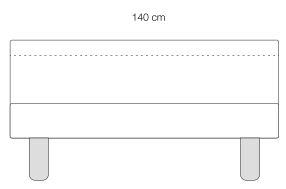
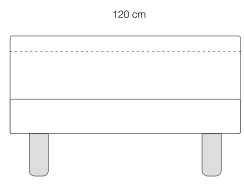
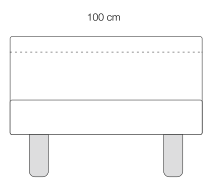
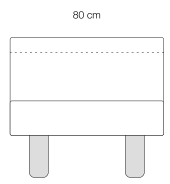

módulo duplo

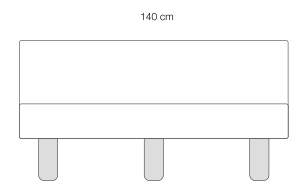
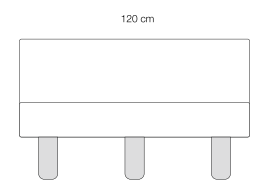
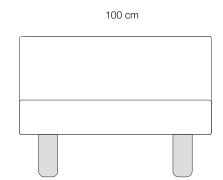

ELEVAÇÃO LATERAL

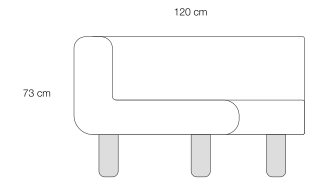

canto

ELEVAÇÃO SUPERIOR

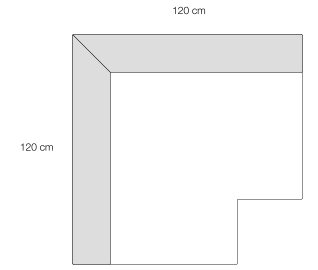

SIDE VIEW

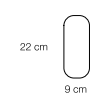

FRONT VIEW



almofadas

60 cm
30 cm
100 cm
120 cm

ELEVAÇÃO
LATERAL

ELEVAÇÃO
FRONTAL

ELEVAÇÃO
LATERAL

ELEVAÇÃO
FRONTAL

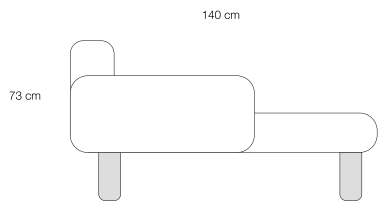

chaise

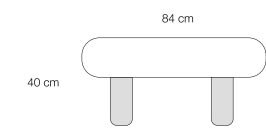
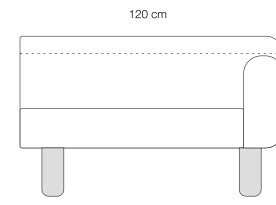
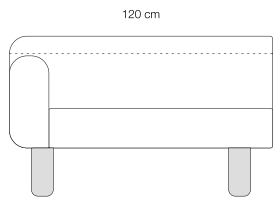
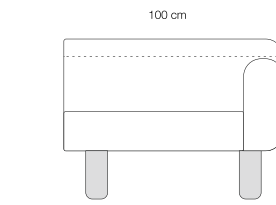
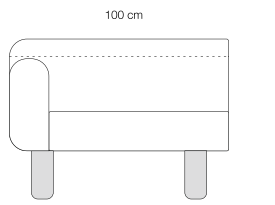

pufe

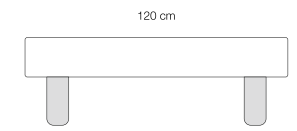
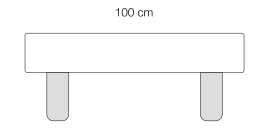
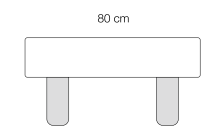

banco

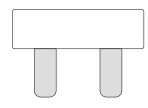



elevação lateral

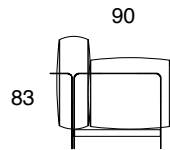

elevação frontal

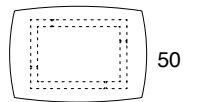
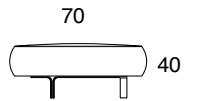
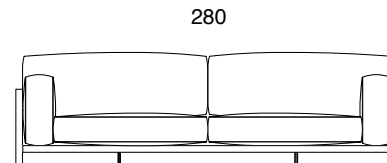
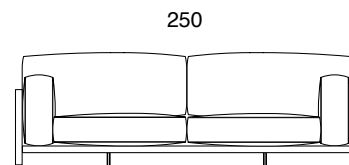
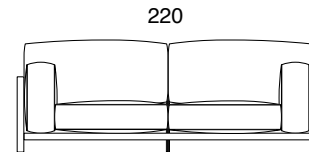
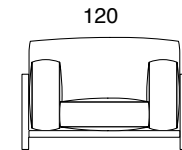
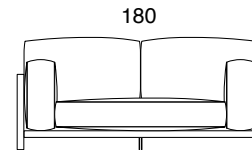

elevação superior



self
sofá-cama

elevação
frontal

196

87

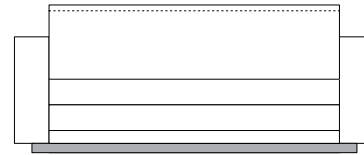

elevação
lateral

195

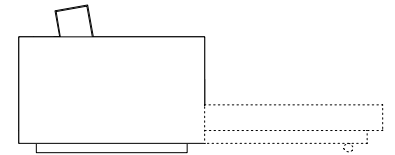



set
sofá

elevação
frontal

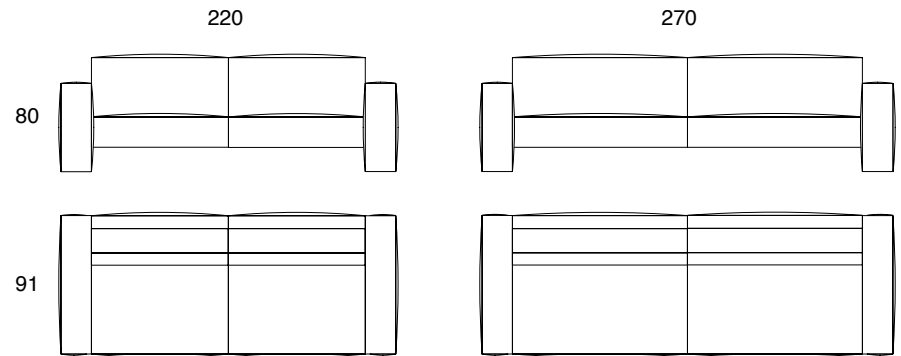
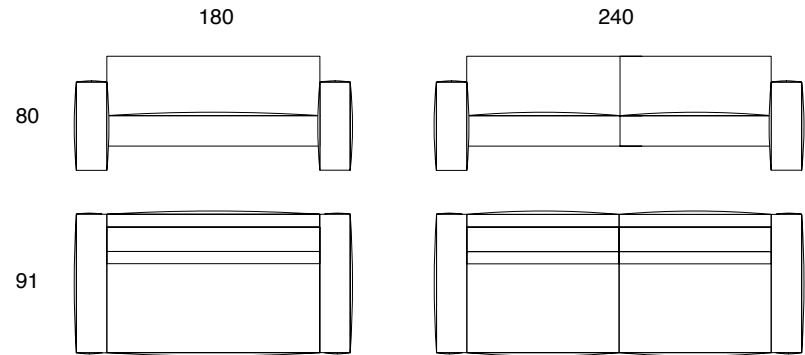

elevação
superior



shell

sofá

elevação lateral

100

70

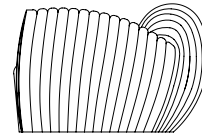

elevação frontal

200

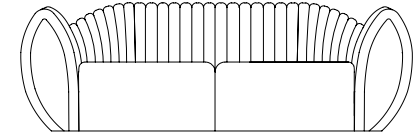

100

70

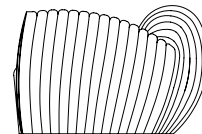

250

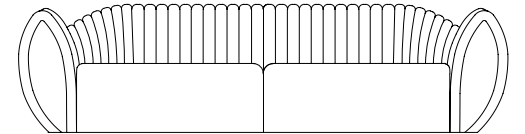

soft
sofá-cama



elevação lateral

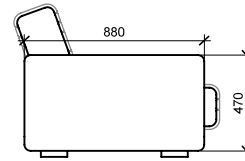

elevação frontal

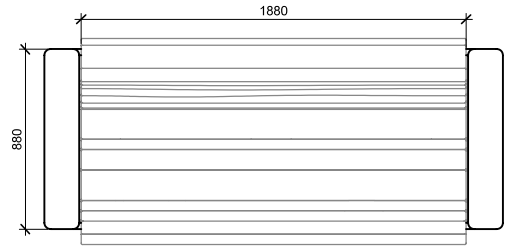
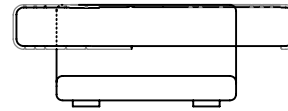
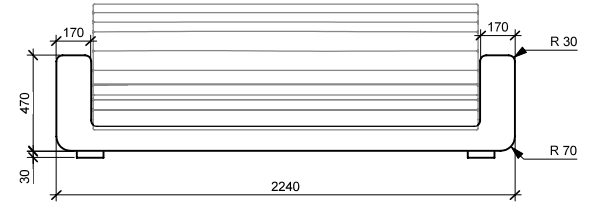

elevação superior

volpi
sofá



elevação lateral

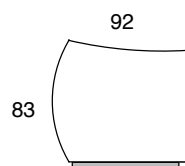

elevação frontal

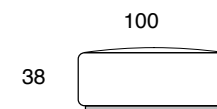
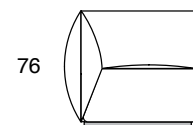
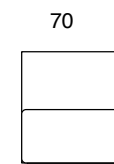
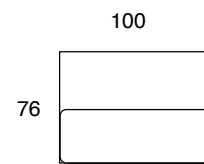
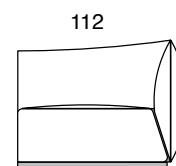
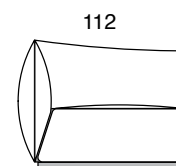



ada
cadeira

elevação
frontal

51 cm

83 cm

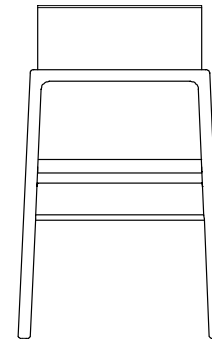

elevação
lateral

54 cm

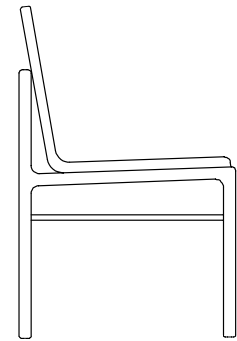

83 cm

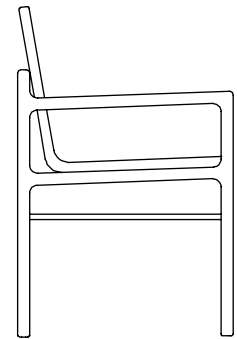
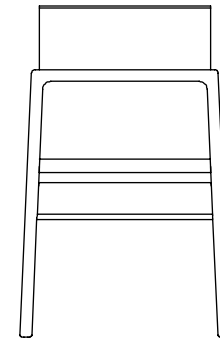



alba
cadeira

elevação
frontal

48

80

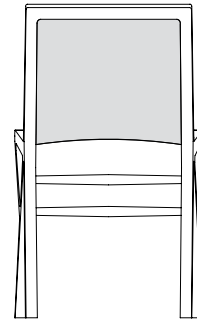

elevação
lateral

60

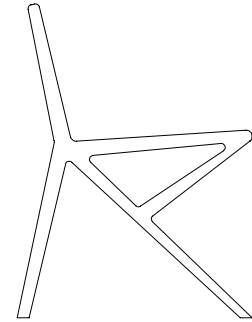

60

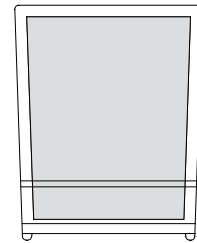

elevação
superior

allegro

cadeira



elevação
frontal

53

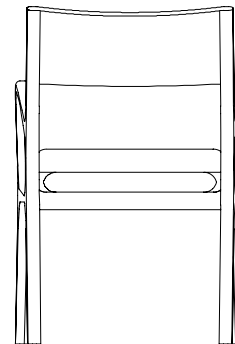

80

elevação
lateral

61

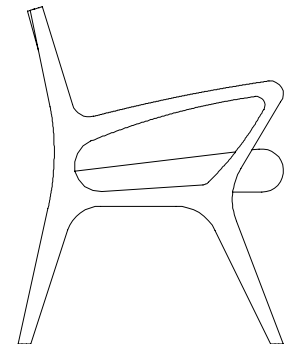



bia
cadeira

elevação lateral

84 cm

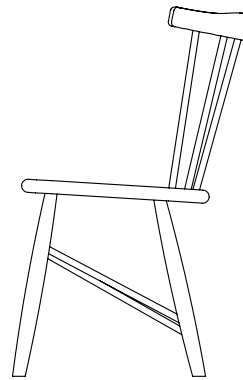

elevação frontal

50 cm

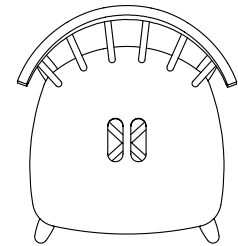
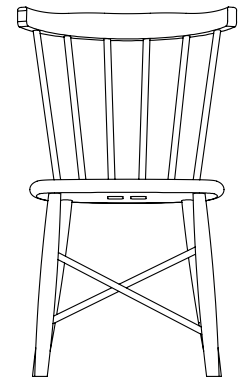

54 cm

elevação superior

clau
cadeira



elevação
frontal

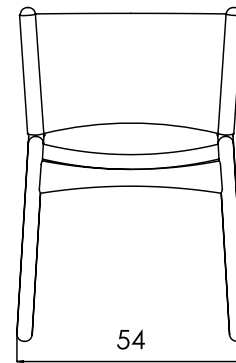

elevação
lateral

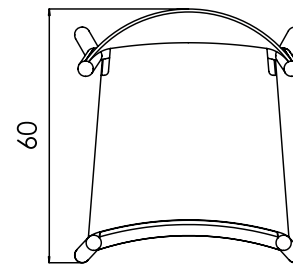
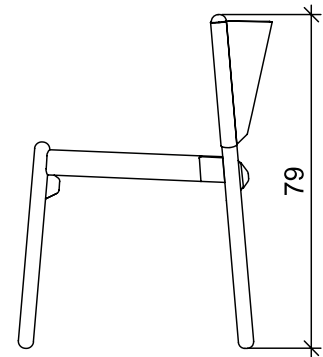

elevação
superior



cris
cadeira

elevação
frontal

elevação
lateral

56

64

82

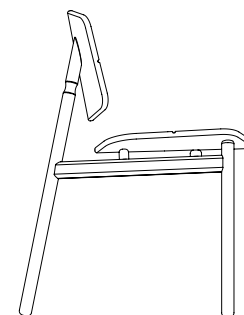
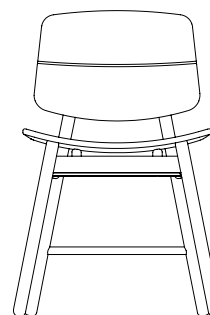

64

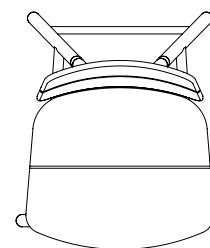

elevação
superior



deby
cadeira

elevação
frontal

55

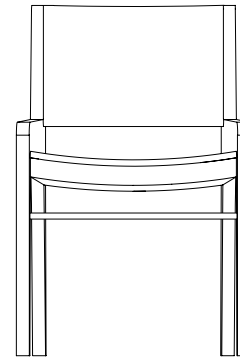

82

elevação
lateral

57

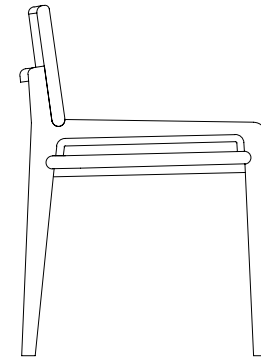

57

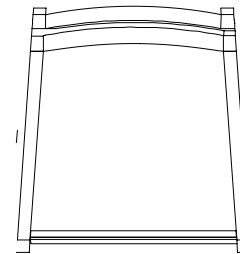

elevação
superior

deca

chair

front
elevation
49 cm5

lateral
elevation
2 cm

87 cm

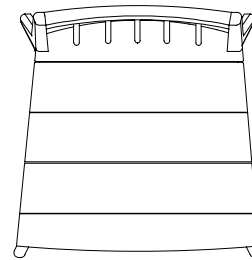
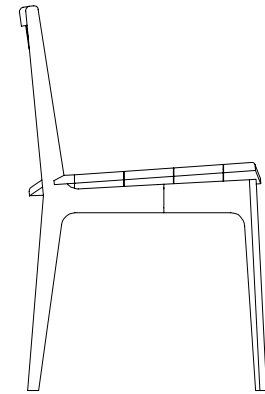
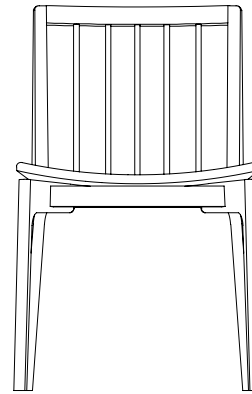

upper
elevation





doca
cadeira

elevação
frontal

elevação
lateral

53

55

83

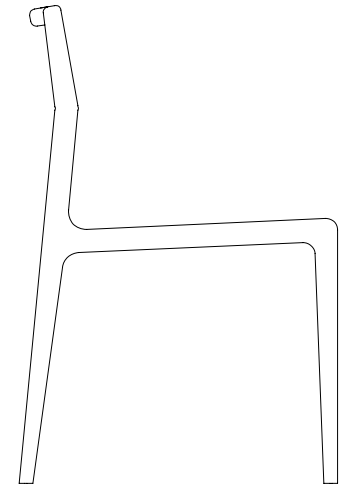
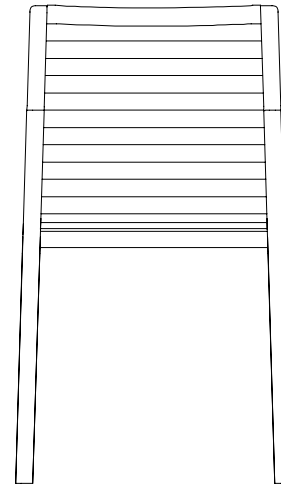



gilda
cadeira

elevação
frontal

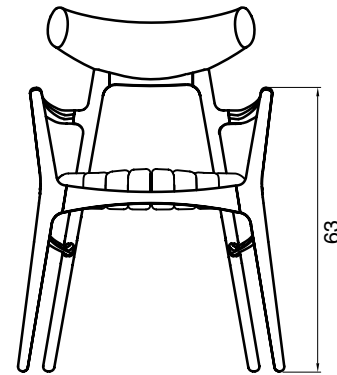

elevação
lateral

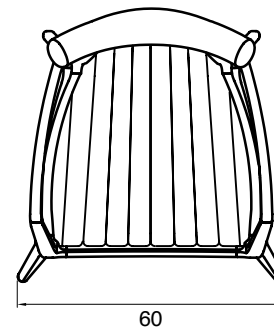
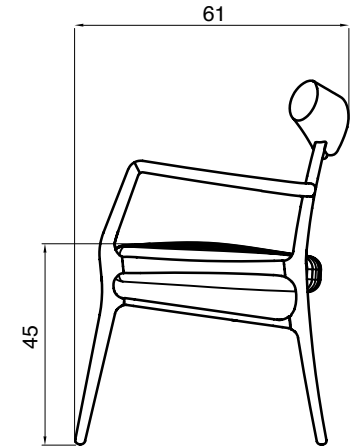

elevação
superior



helga

cadeira

elevação lateral

elevação frontal

51

53

80

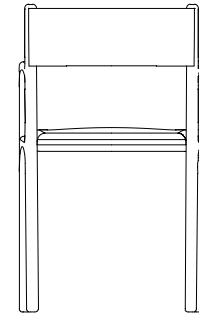
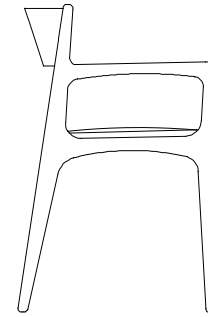

52

48

80

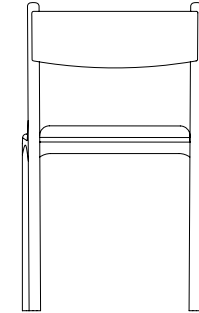
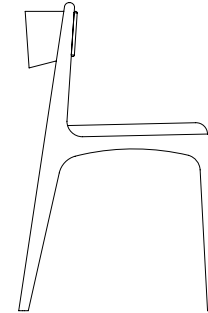



luisa

cadeira

elevação frontal

elevação lateral

53

55

81

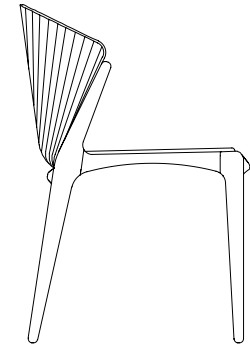
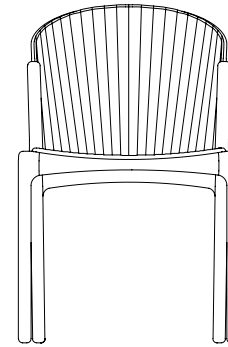

55

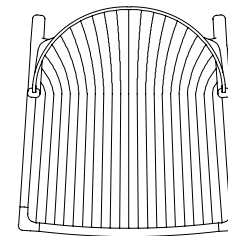

elevação superior



maria
cadeira

elevação
frontal

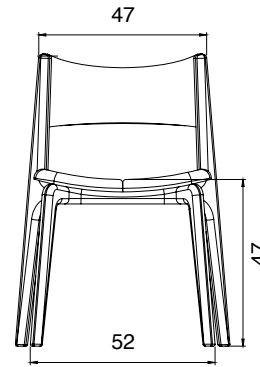

elevação
lateral

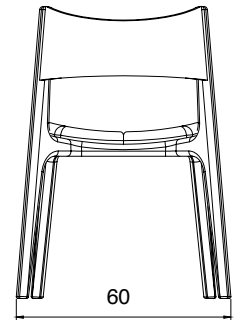
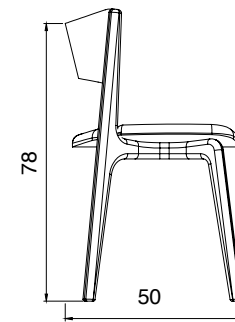



mariana

cadeira

elevação
frontal

48

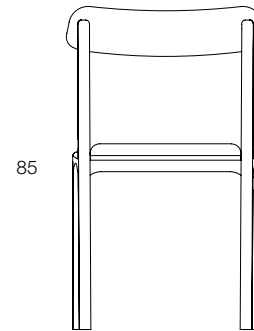

85

elevação
lateral

52

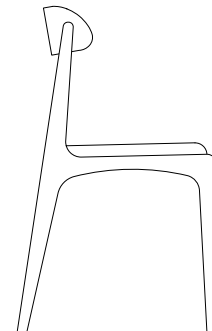

53

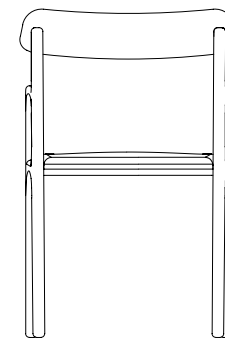

85

52

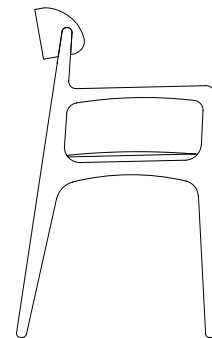



mirella
cadeira

elevação
frontal

53

81

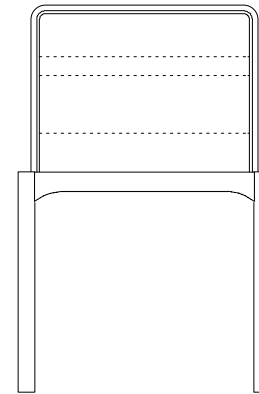

elevação
lateral

53

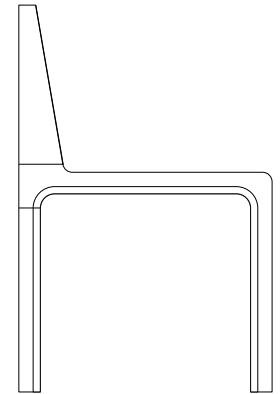

paty
cadeira



elevação
frontal

elevação
lateral

48 cm5

6 cm

83 cm

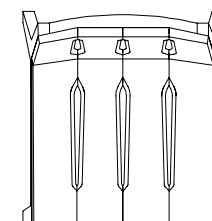
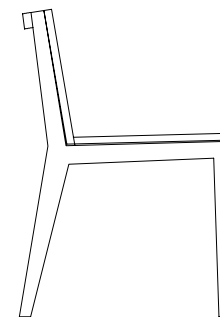
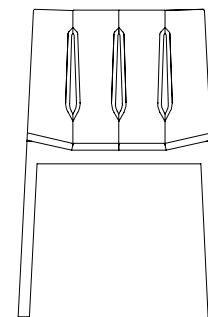

elevação
superior



sottile
cadeira

elevação
frontal

54

84

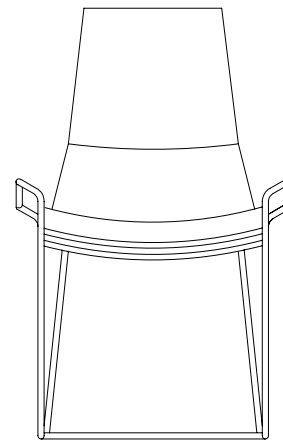

elevação
lateral

57

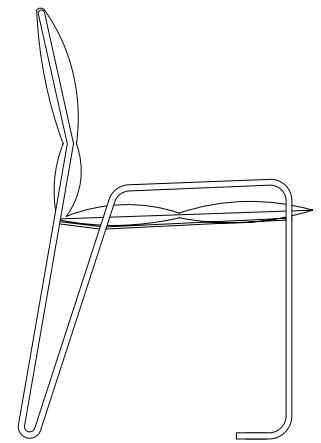



tata
cadeira

elevação
frontal

elevação
lateral

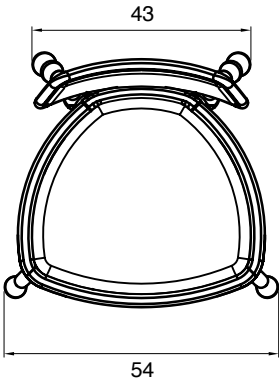
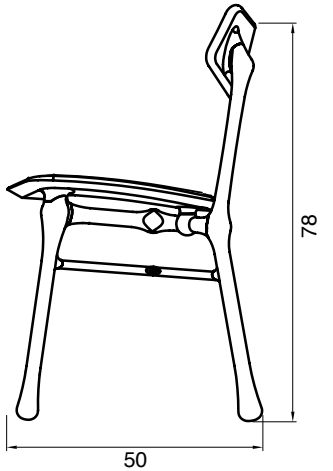
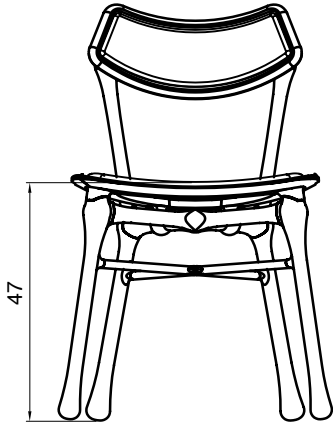

elevação
superior

tati
cadeira



elevação
frontal

elevação
lateral

54 cm

50 cm

80 cm

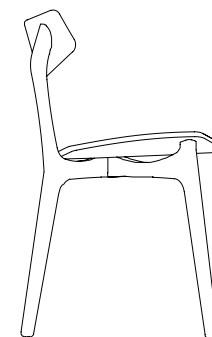
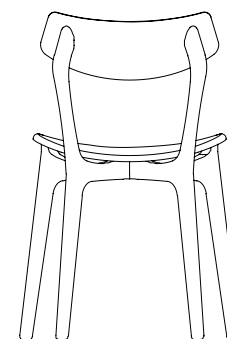

60 cm

53 cm

80 cm

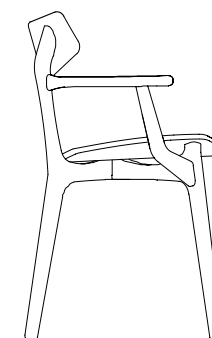
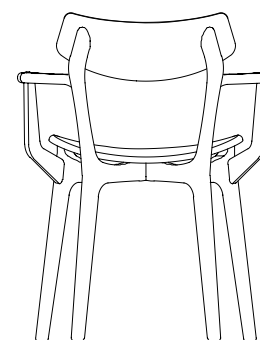



topo
cadeira

elevação
frontal

elevação
lateral

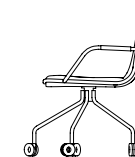
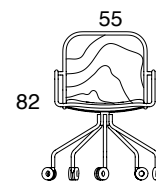
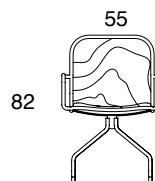
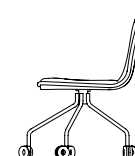
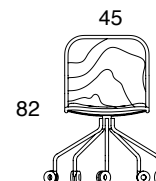
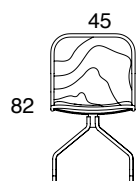

yoná
cadeira



elevação
frontal

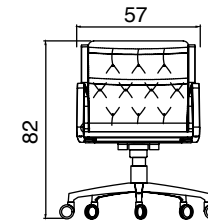

elevação
lateral

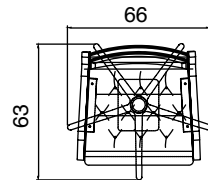
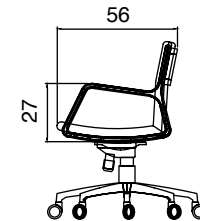

elevação
superior

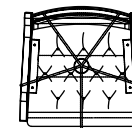
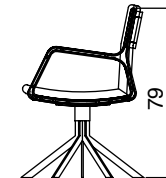
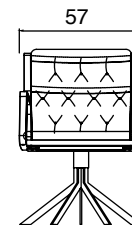



zia
cadeira

elevação
frontal

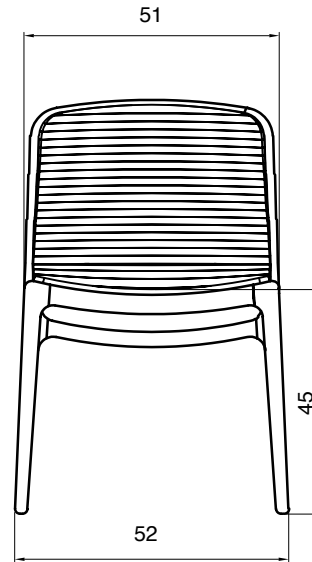

elevação
lateral

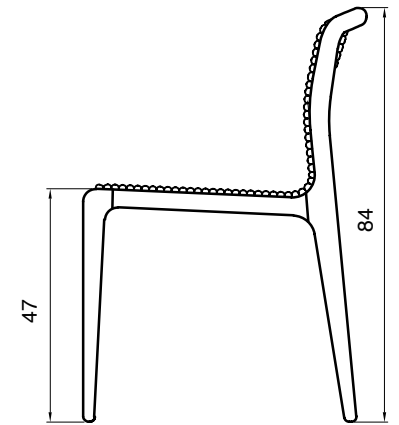

estudiobola  mesas de jantar



arq
mesa de jantar

elevação
frontal

elevação
lateral

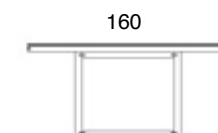
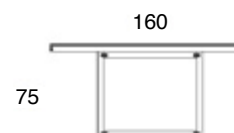
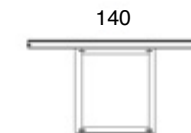
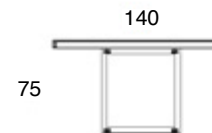
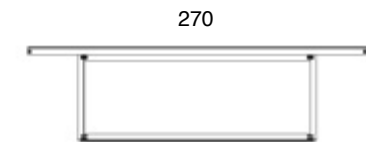
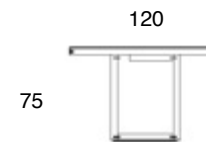
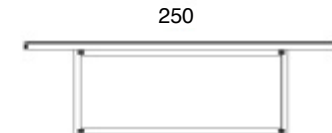
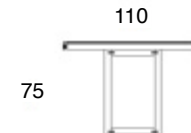
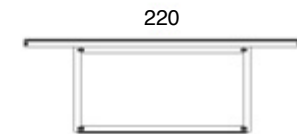
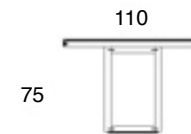
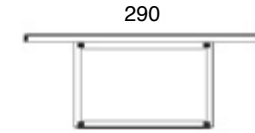
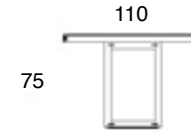



balloon

mesa de jantar

elevação lateral

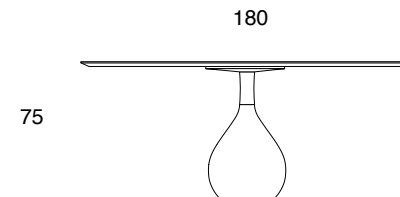
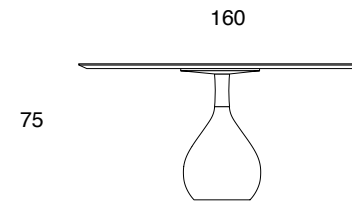
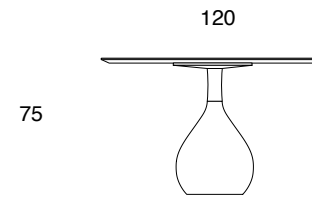



balloon

mesa de jantar

elevação
frontal

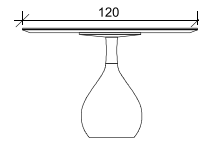

elevação
lateral

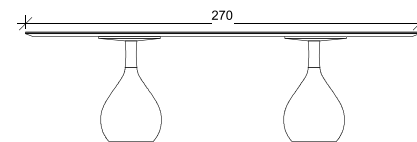
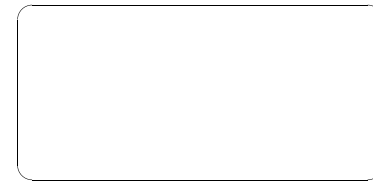
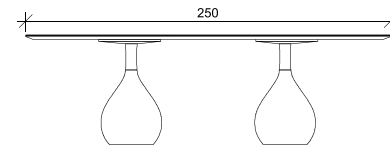
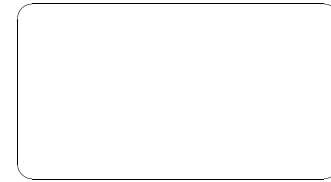
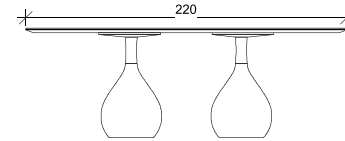



concrete

mesa de jantar

elevação lateral

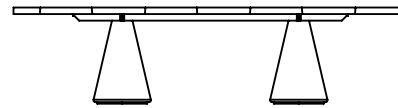

elevação frontal

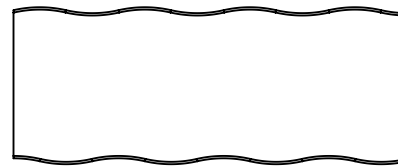

elevação superior

- L 200 P 110 A 75
- L 220 P 110 A 75
- L 240 P 120 A 75
- L 260 P 120 A 75
- L 280 P 120 A 75
- L 300 P 120 A 75



forte
mesa de jantar

elevação
frontal

elevação
lateral

120

210

75

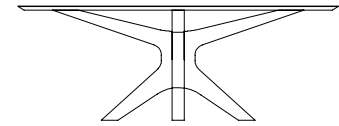
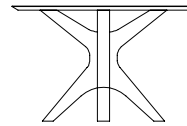

140

250

75

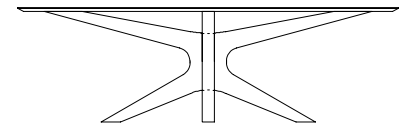
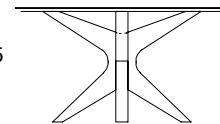

140

270

75

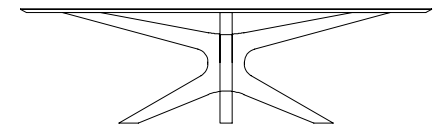
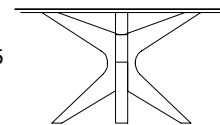



lena

mesa de jantar

elevação lateral

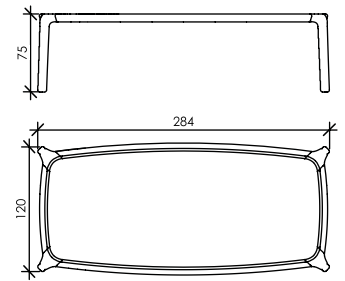
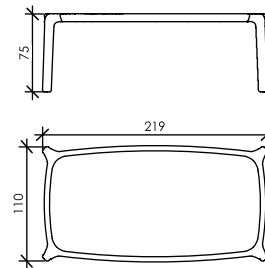
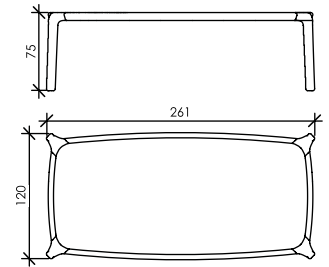
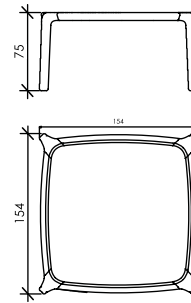

elevação superior



maria

mesa de jantar

elevação lateral

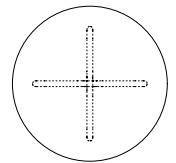
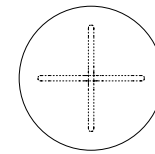
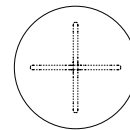
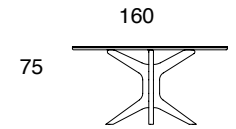
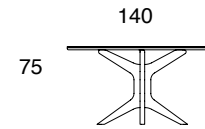
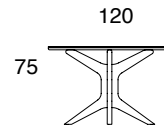

elevação superior



maria

mesa de jantar

elevação frontal

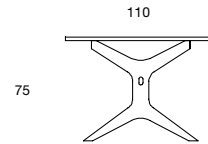

elevação lateral

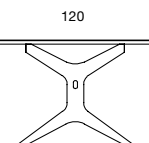
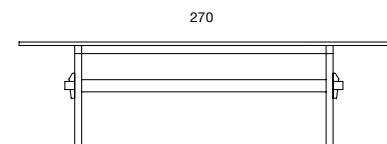
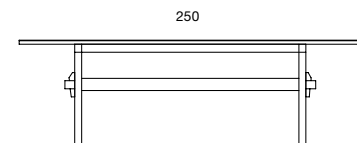
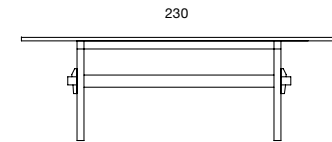
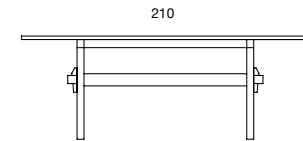
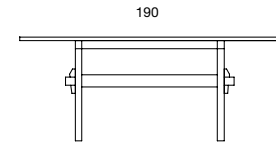



y

mesa de jantar

elevação lateral



elevação frontal

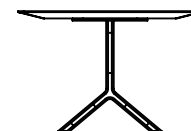

elevação superior

- L 200 P 110 A 76
- L 220 P 110 A 76
- L 240 P 110 A 76
- L 260 P 110 A 76
- L 280 P 110 A 76
- L 300 P 110 A 76



areté

banco

elevação
frontal

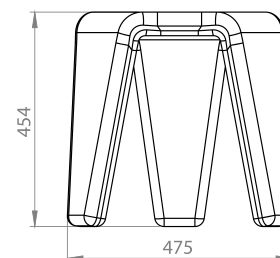

elevação
lateral

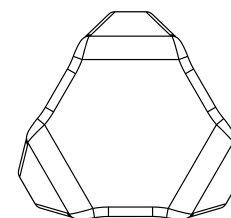
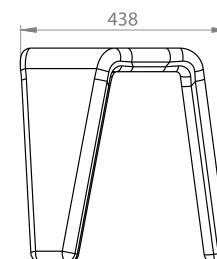

elevação
superior



arq
banco

elevação lateral

elevação frontal

45

45

45

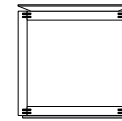
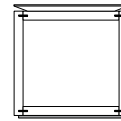

140

45

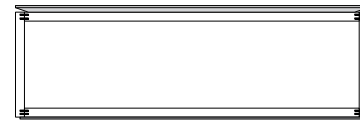
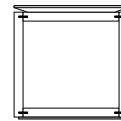

180

45

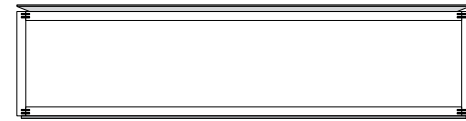
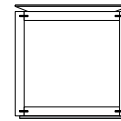

220

45

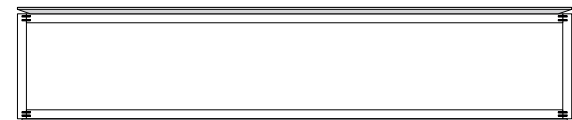
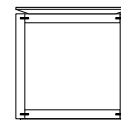



carretel

banco

elevação
frontal

40 cm

45 cm

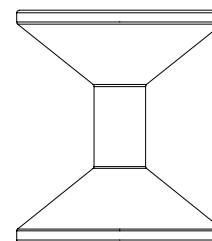

elevação
lateral

40 cm

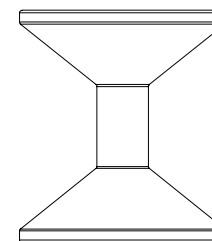

elevação
superior

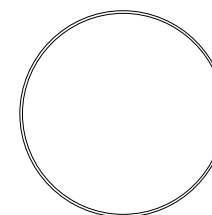



cave
banco

elevação
frontal

elevação
lateral

33 cm

33 cm

42 cm

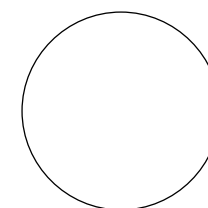
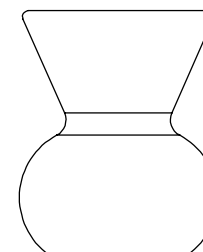
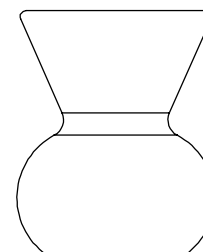

elevação
superior



kork
banco

elevação
frontal

40 cm

40 cm

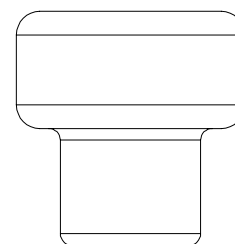

elevação
lateral

40 cm

24 cm

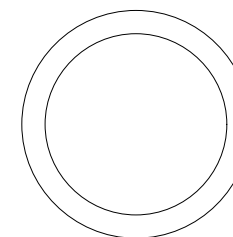
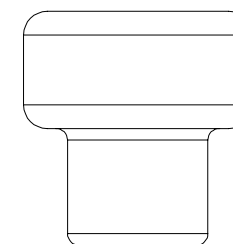

elevação
superior



less
banco

elevação
frontal

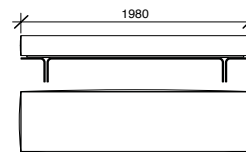
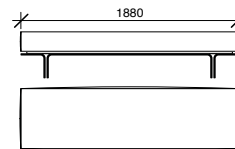
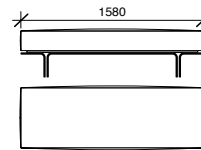
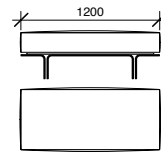

elevação
lateral

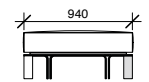
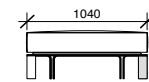

elevação
superior

trebbi

banco

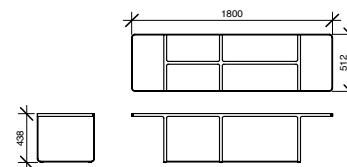
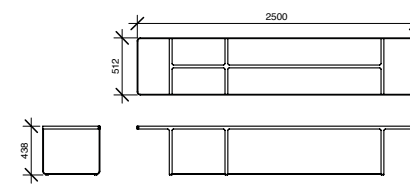
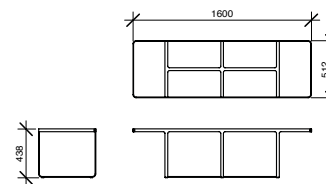
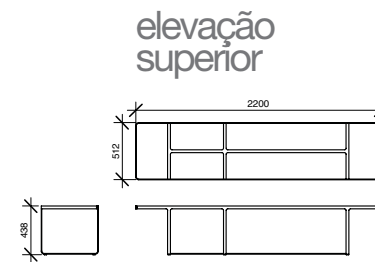
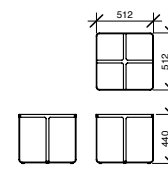

elevação lateral elevação frontal

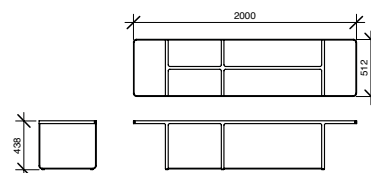



viki
banco

elevação
frontal

elevação
lateral

45 cm

45 cm

45 cm

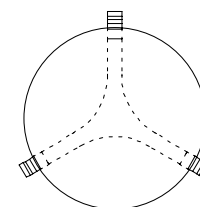
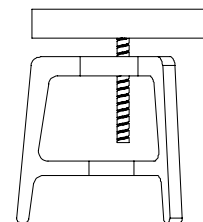
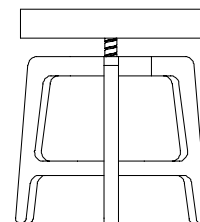

elevação
superior

will
banco



elevação
lateral

48 cm

46 cm

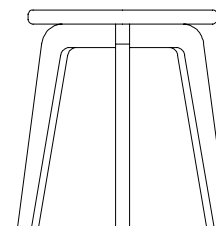

elevação
frontal

48 cm

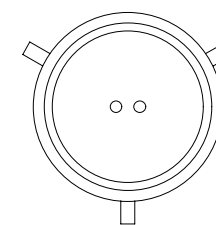
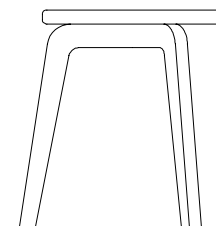

elevação
superior

estudiobola  banquetas

ada
banqueta



elevação
lateral

elevação
frontal

44 cm

42 cm

97 cm

72 cm

44 cm

elevação
superior

helga

banqueta

elevação lateral

elevação frontal

45 cm

45 cm

93 cm

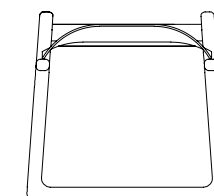
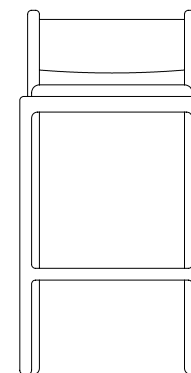
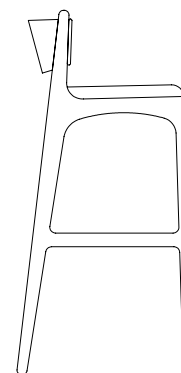

elevação superior



luisa
banqueta



elevação
frontal

46

97

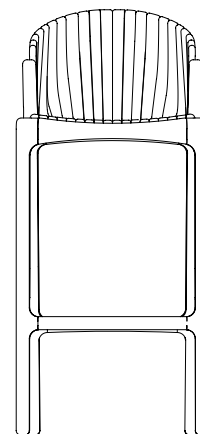

elevação
lateral

45

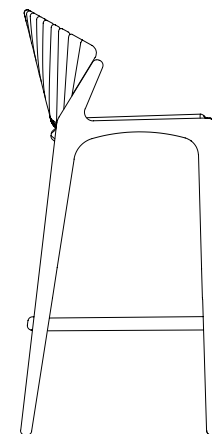

45

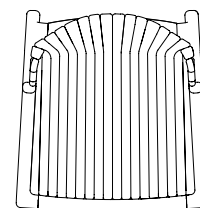

elevação
superior

mirella

banqueta



elevação lateral

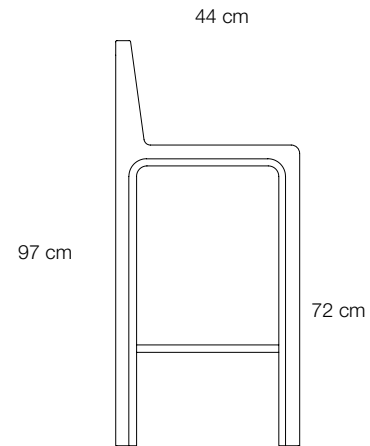

elevação frontal

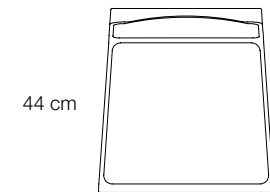
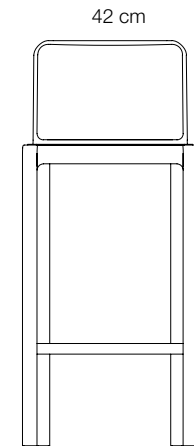

elevação superior



elevação lateral

47 cm

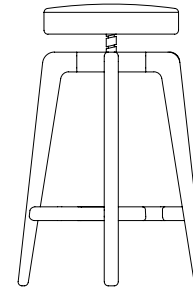

65 a 72 cm

elevação frontal

47 cm

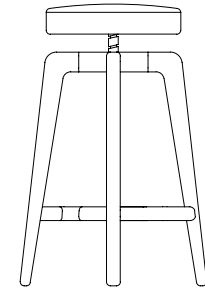

47 cm

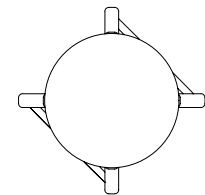

elevação superior



elevação lateral

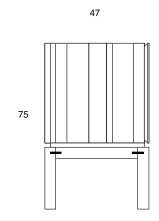

elevação frontal

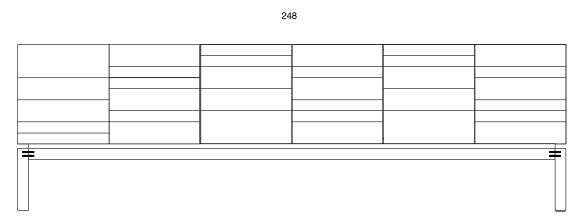
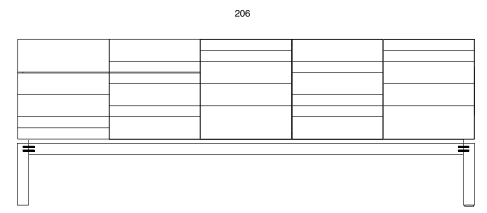
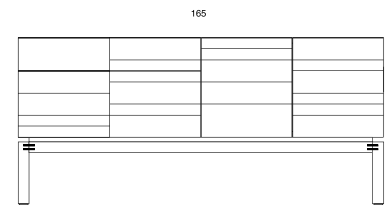
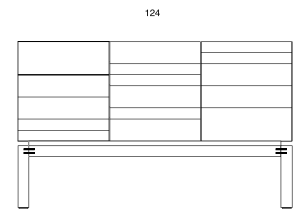

elevação
frontal

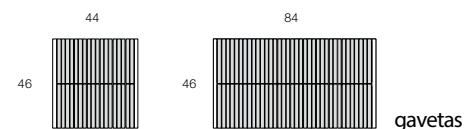
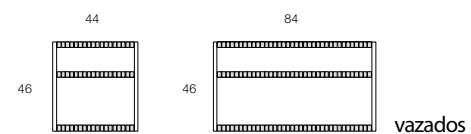
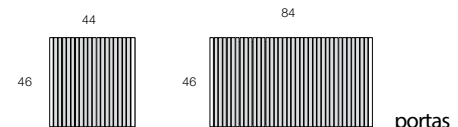

elevação
lateral

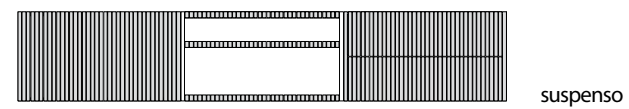
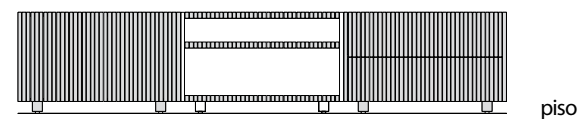
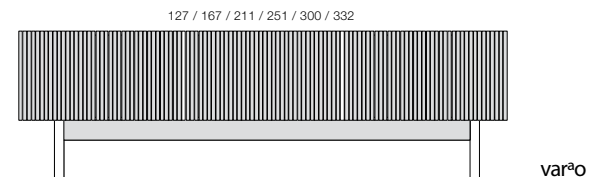
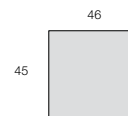
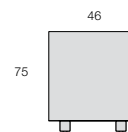
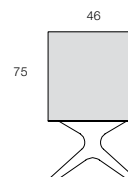



elevação lateral

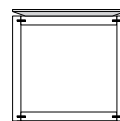
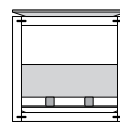
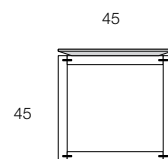

elevação frontal

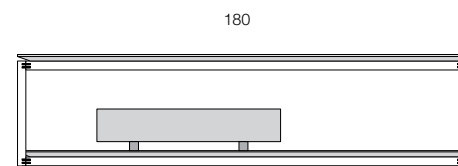
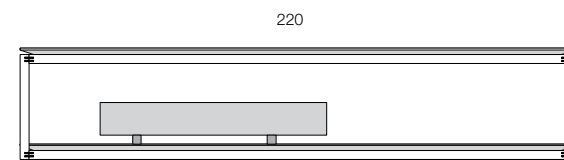
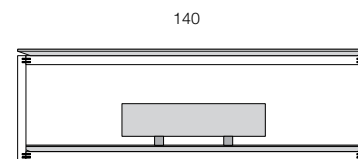

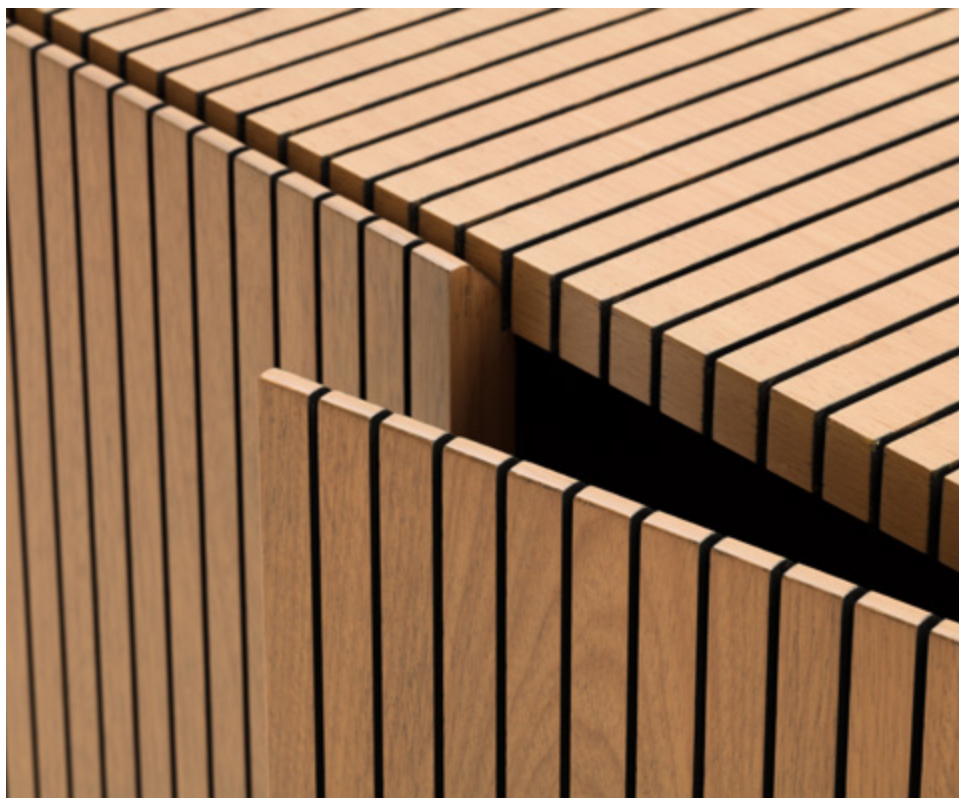

soma
home

elevação frontal

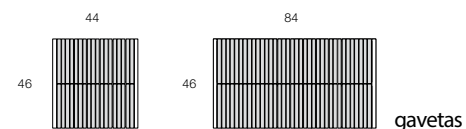
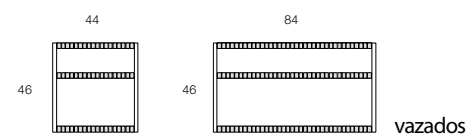
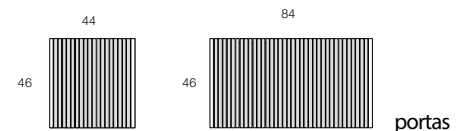

elevação lateral

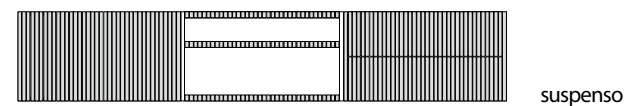
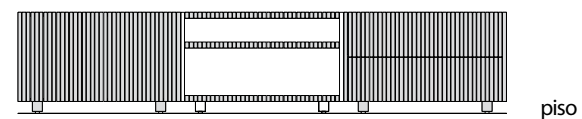
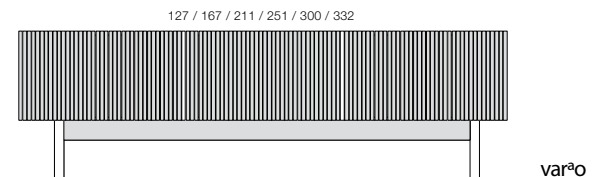
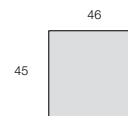
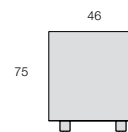
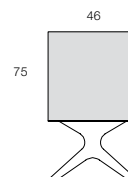

elevação
lateral

42

46



elevação
frontal

160

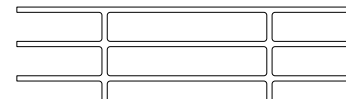

180

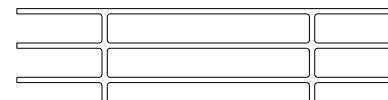

200

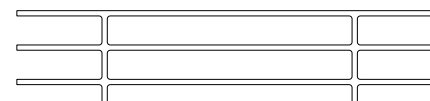

220

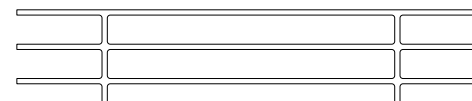

estudiobola  mesas laterais



árdea

mesa lateral

elevação lateral

elevação frontal

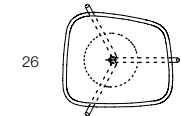
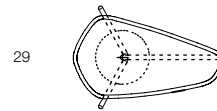
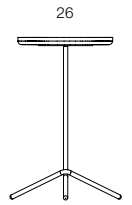
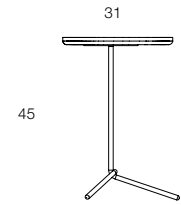
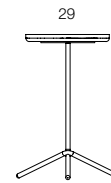
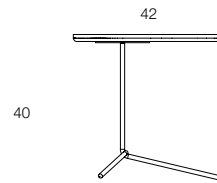

elevação superior

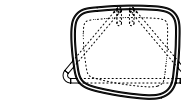
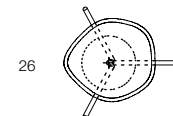
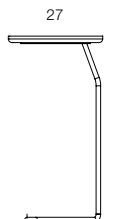
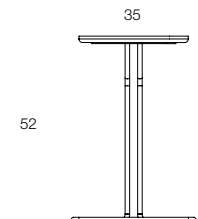
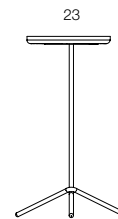
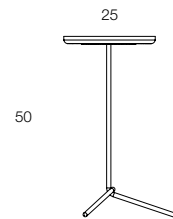



balloon

mesa lateral

elevação lateral

elevação superior

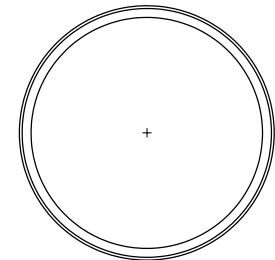
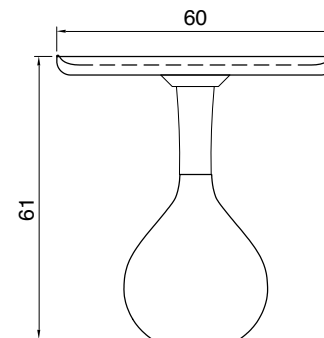
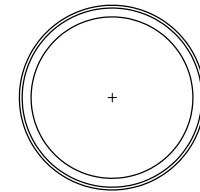
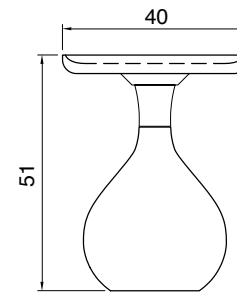



fit
 mesa lateral

elevação
 frontal

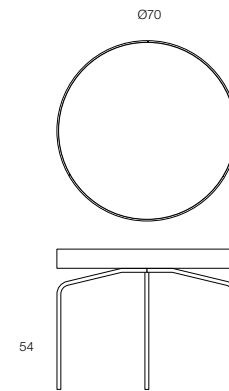
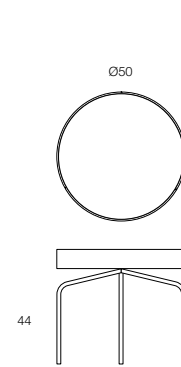
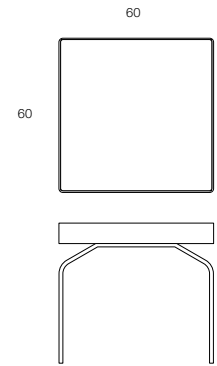
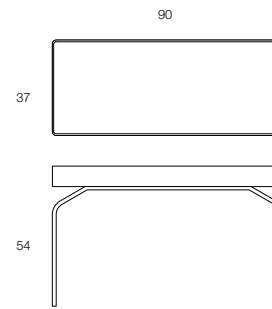

elevação
 superior



grid
mesa lateral

elevação superior

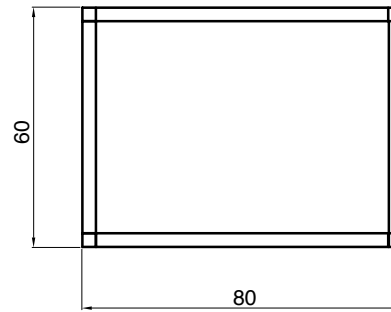

elevação frontal

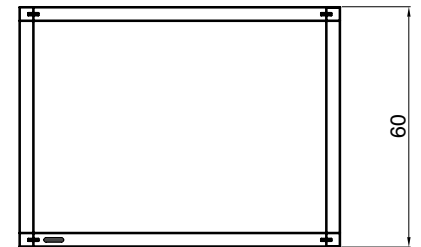
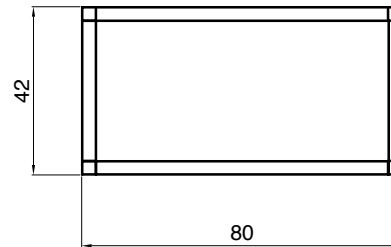
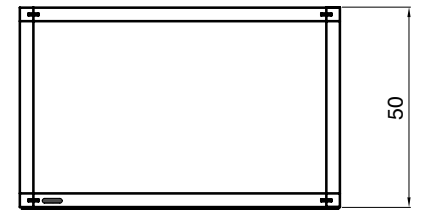



ninho

mesa lateral

elevação lateral

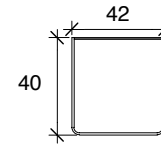

elevação frontal

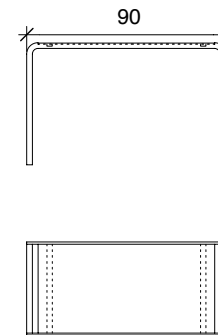
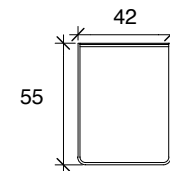
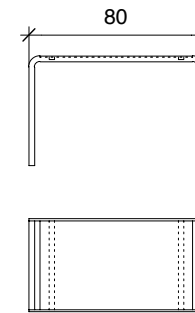
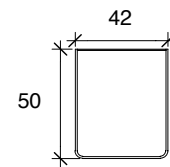
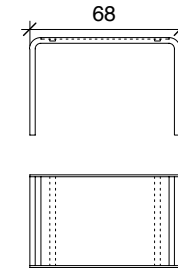

elevação superior

rios
mesa lateral



elevação
lateral

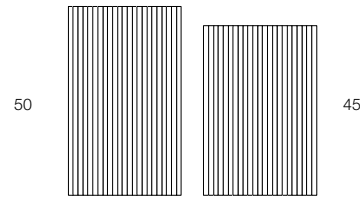

elevação
frontal

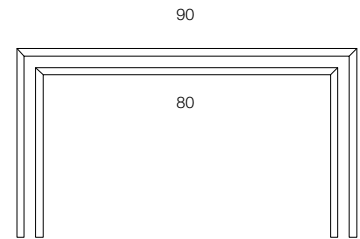

trebbi

mesa lateral



elevação
lateral

42

45

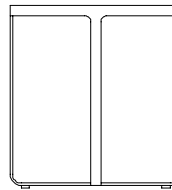

70

60

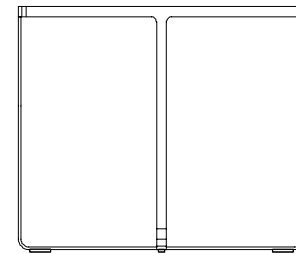



viki
mesa lateral

elevação lateral

elevação frontal

40

43

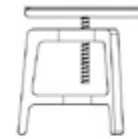

60

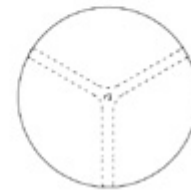

elevação superior

estudiobola  mesas de centro



elevação
lateral

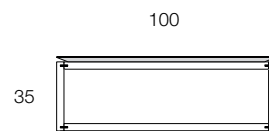

elevação
frontal

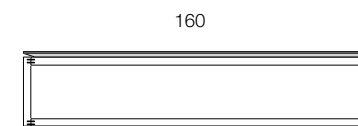
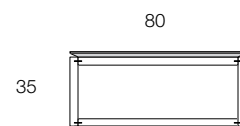
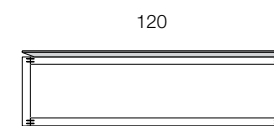
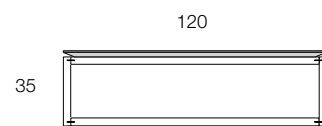
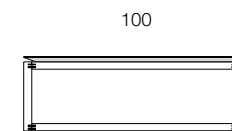
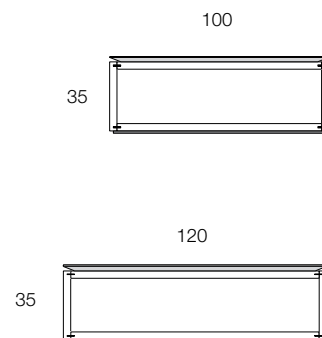



bottom

mesa de centro

elevação lateral



elevação frontal

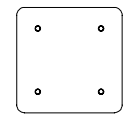
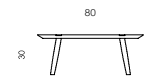
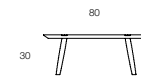
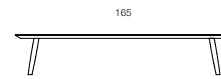

superior

elevação superior

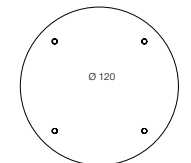
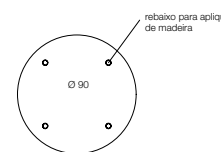
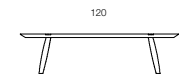
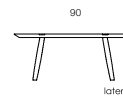
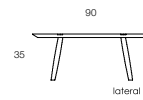



cella

mesa de centro

elevação
frontal

58

30

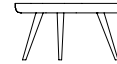

elevação
lateral

99

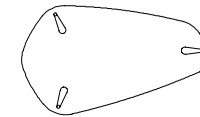
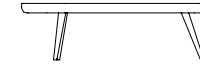

58

36

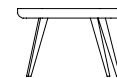

67

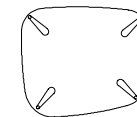
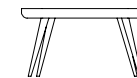

51

42

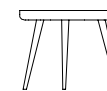

56

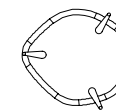

elevação
superior



chipre

mesa de centro

elevação lateral

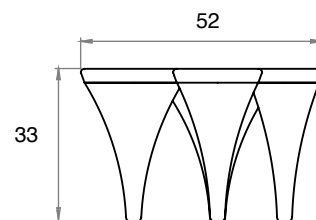

elevação frontal

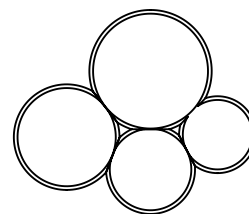
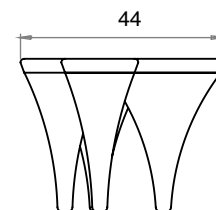

elevação superior

domitila

mesa de centro



elevação lateral

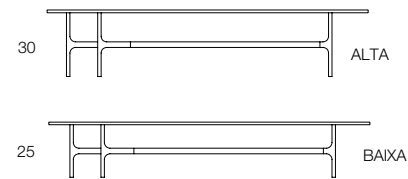

elevação superior

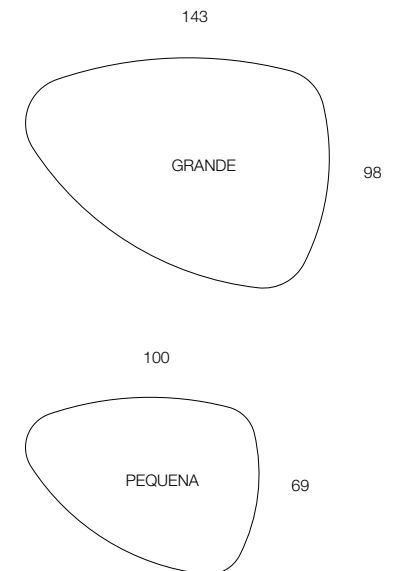



fit

mesa de centro

elevação superior

elevação lateral

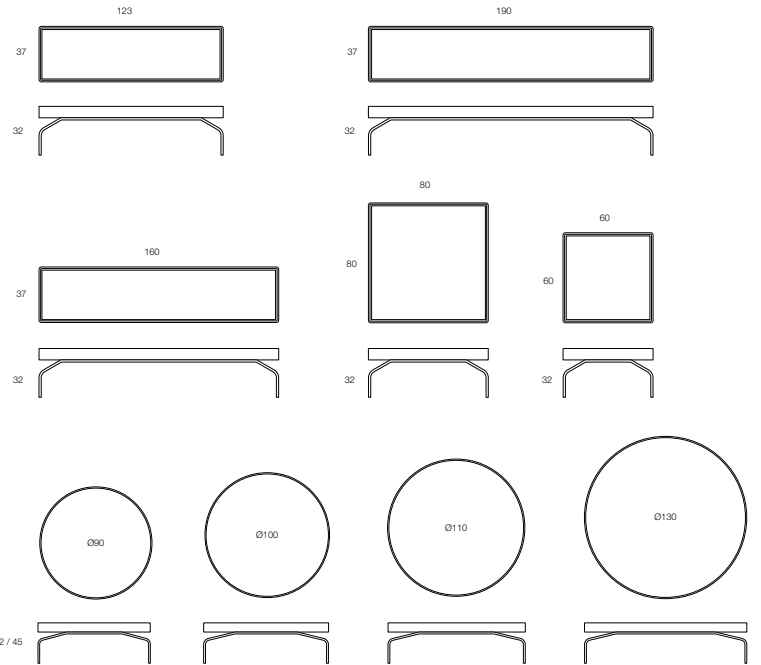



grid

mesa de centro

elevação superior

elevação lateral

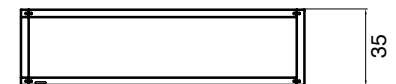
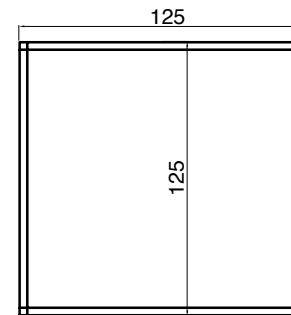
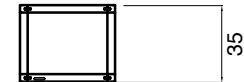
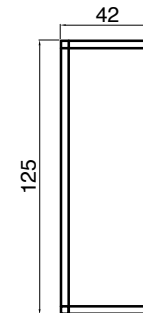
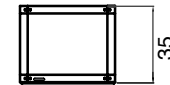
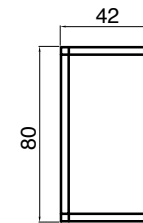
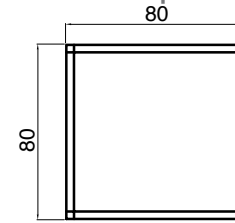

lens

mesa de centro

elevação lateral

elevação frontal

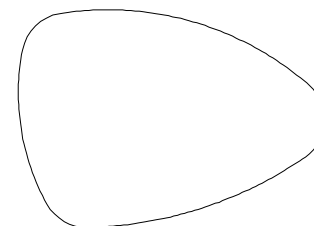
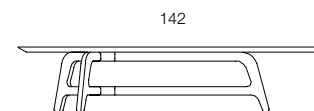
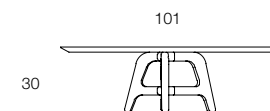
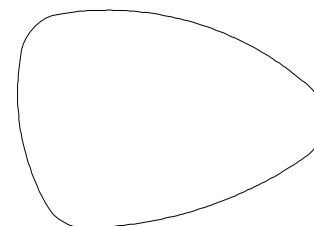
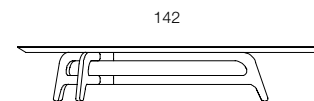
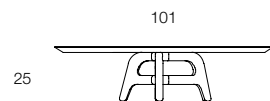

elevação superior



trebbi longa

mesa de centro

elevação lateral

52

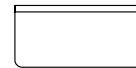

25

elevação frontal

160

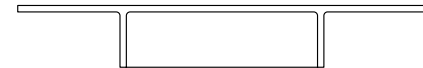

180



200

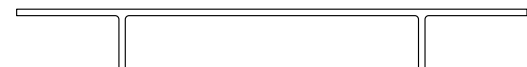

220



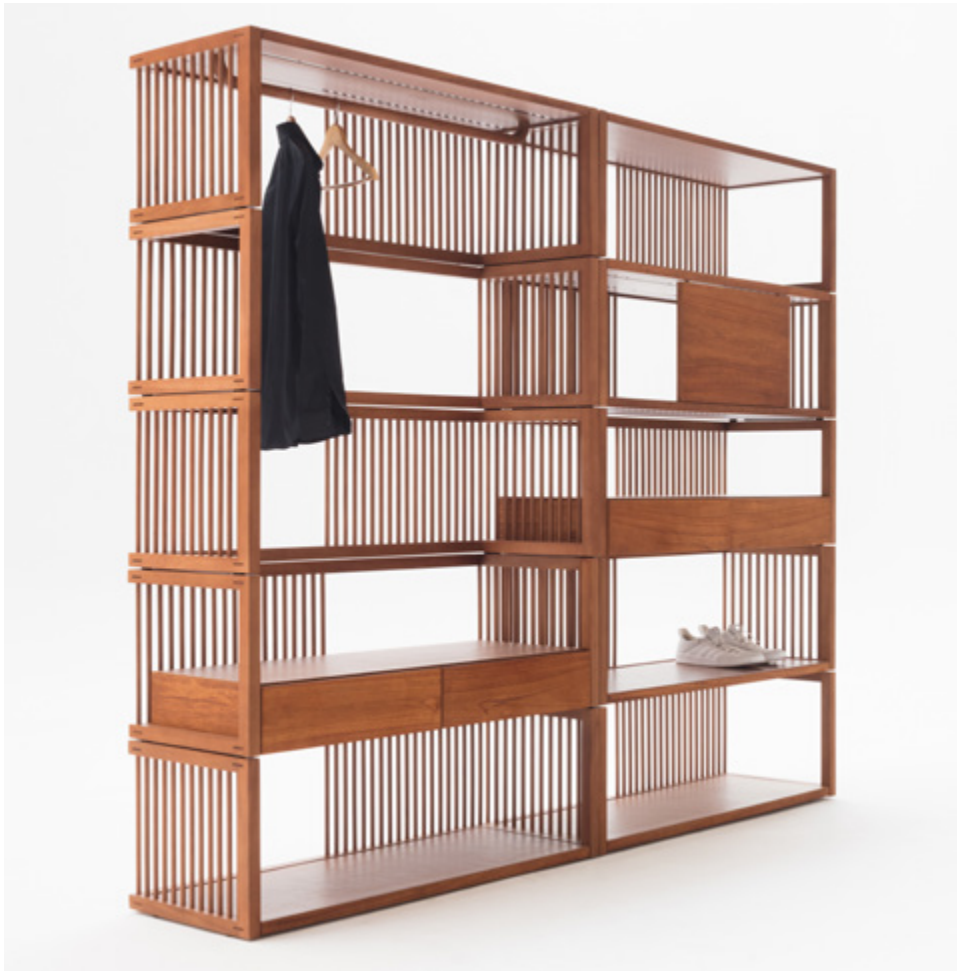

grid
estante

elevação
frontal

elevação
lateral

240

42

202

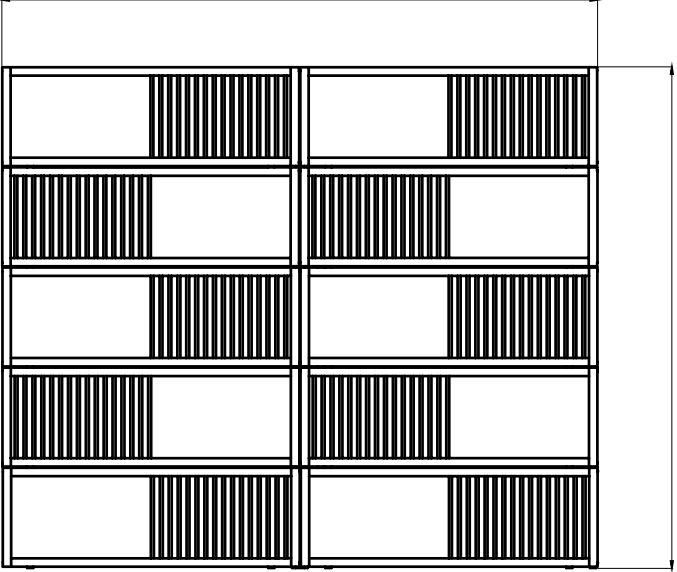

estudiobola  aparadores



arq
aparador

elevação
frontal

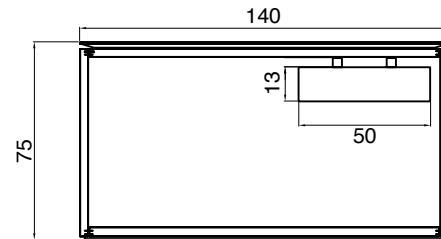

elevação
lateral

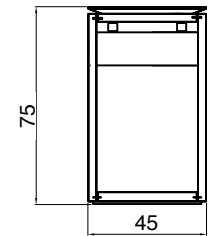

180

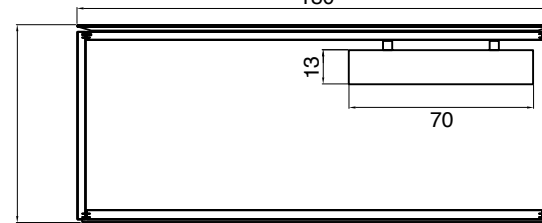

220

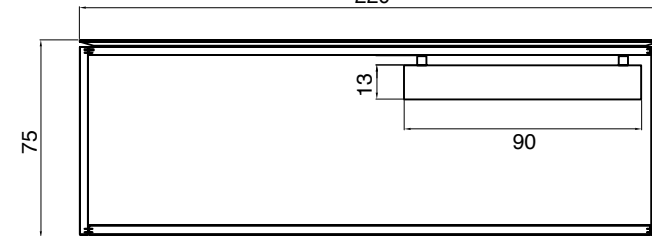



grid

aparador

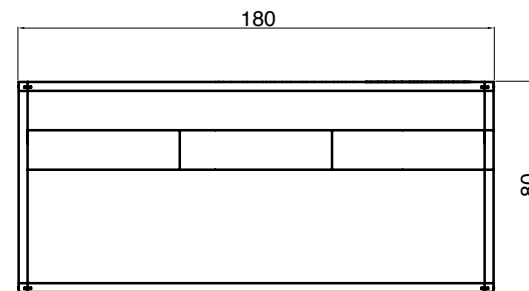

elevação frontal

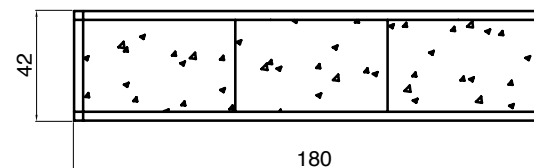

elevação superior

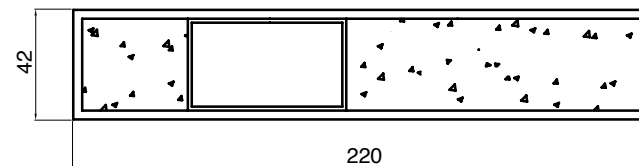
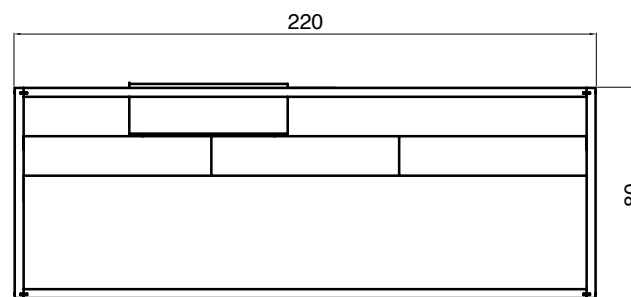

criado arq

gaveteiro



elevação lateral

40

52

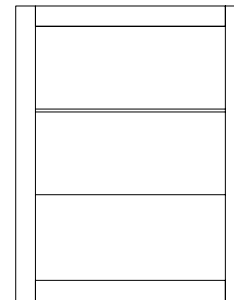

elevação frontal

50

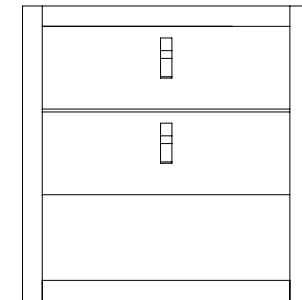

40

52

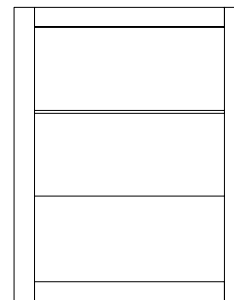

70

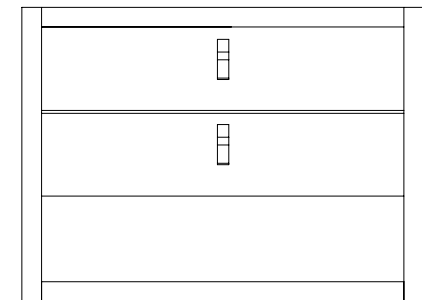



cômoda arq

gaveteiro

elevação lateral

45

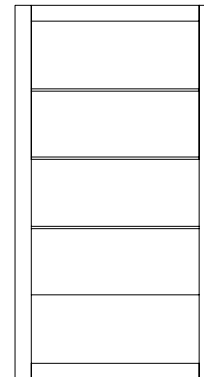

85

elevação frontal

100

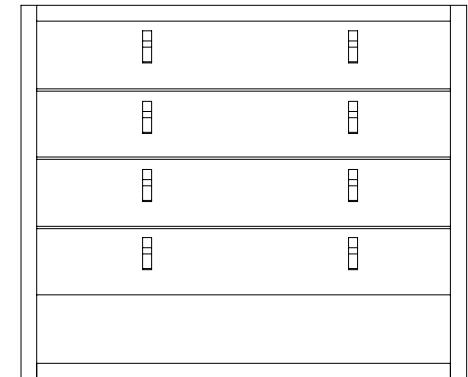



torre arq

gaveteiro

elevação lateral

elevação frontal

40

40

110

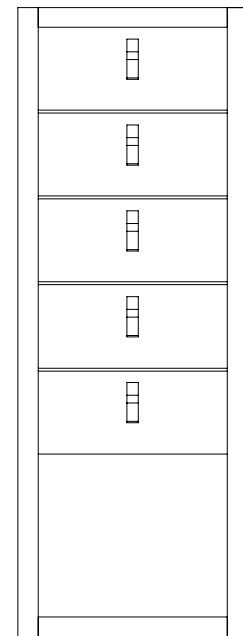
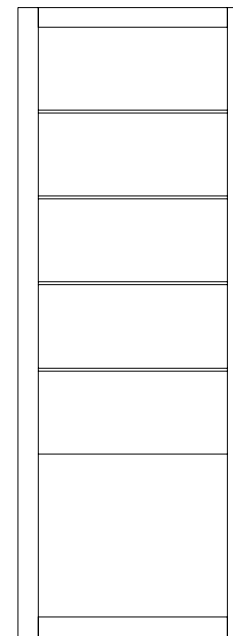

less
cama



elevação
lateral

elevação
frontal

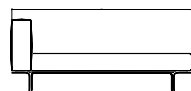

Cama Less 88x188

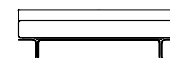
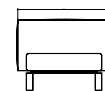

Cama Less 138x188

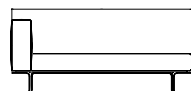

Cama Less 158x188

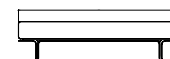
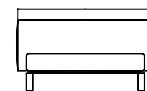

Cama Less 158x198

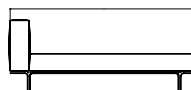
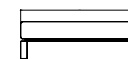

Cama Less 193x198

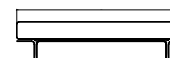
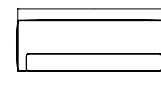

Cama Less 193x203

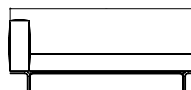
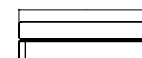

Cama Less 193x203

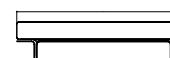
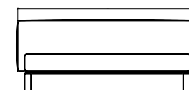

Cama Less 193x203

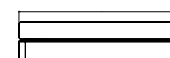



cella
espelho

elevação lateral

elevação frontal

5

56

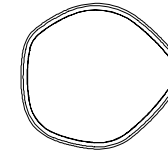

5

67

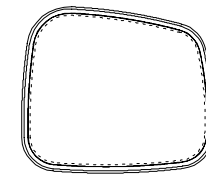

5

99

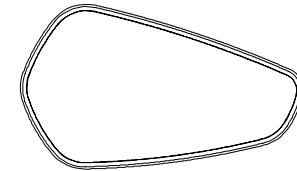



elevação lateral



elevação frontal

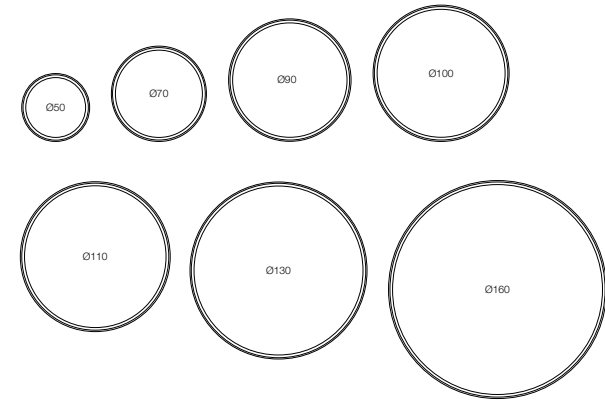
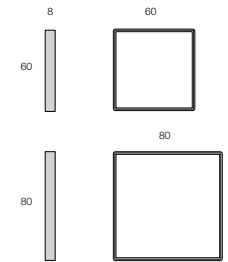
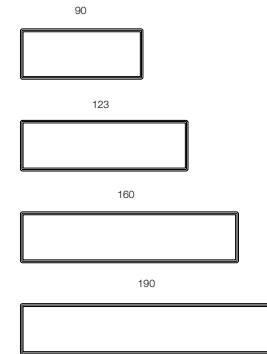



loreto cabideiro

espelho

elevação lateral

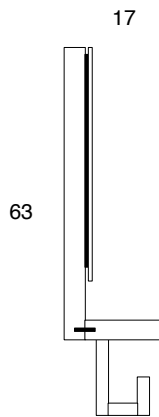

elevação frontal

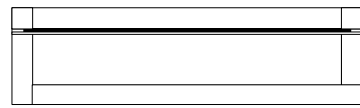
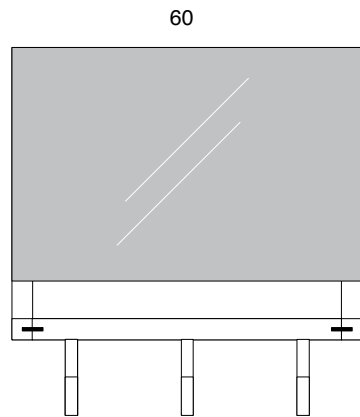

upper elevation



loreto prateleira

espelho

elevação lateral

23

114

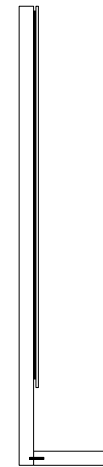

elevação frontal

60

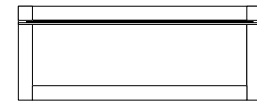
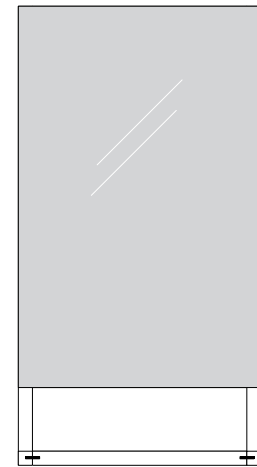

elevação superior



loreto gaveta

espelho

elevação lateral

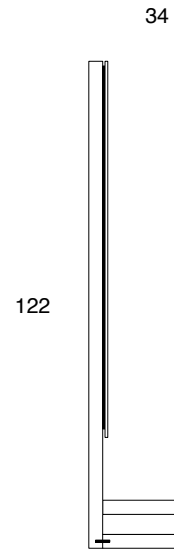

elevação frontal

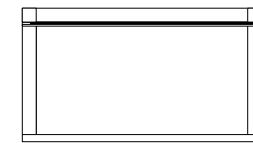
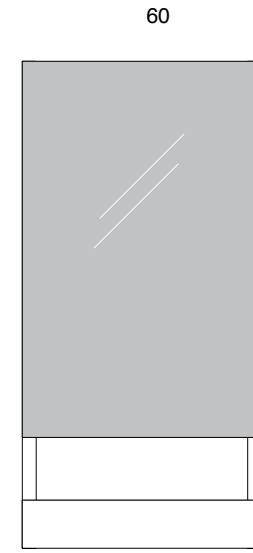

elevação superior



loreto porta guarda-chuva

espelho

elevação lateral

elevação frontal

23

60

163

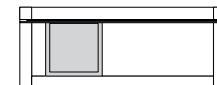
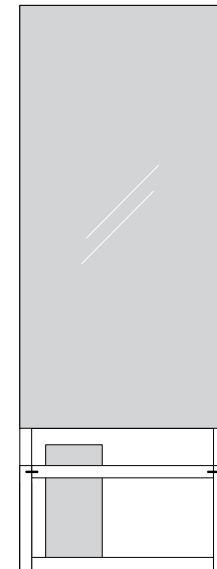
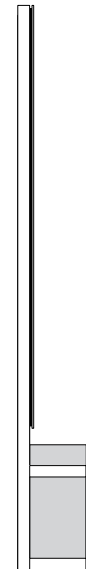

elevação superior

loreto cavalete

espelho



elevação lateral

22

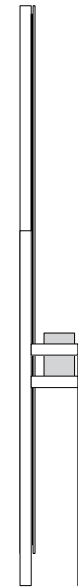

180

elevação frontal

63

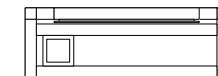
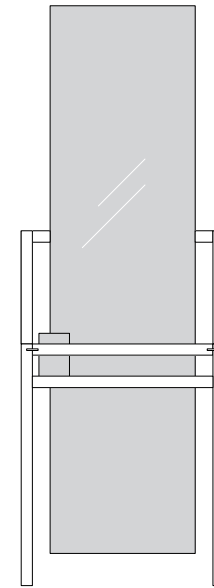

elevação superior

estudiobola  luminárias



abajur frise

luminária

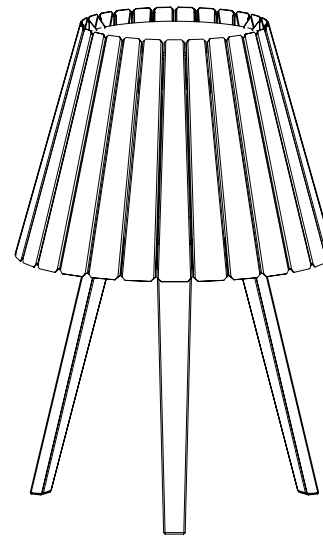

L 44 P 44 A 65

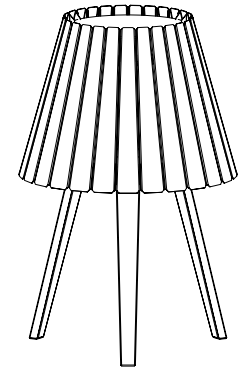

L 29 P 29 A 42

visão
isométrica



abajur plier

luminária

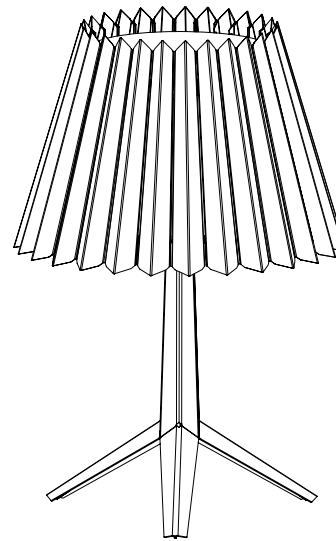

L 44 P 44 A 65

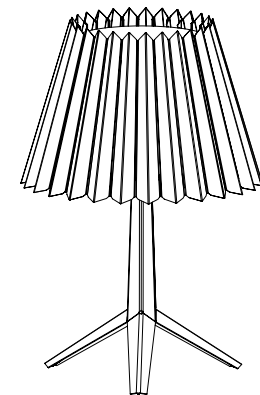

L 29 P 29 A 42

visão
isométrica



coluna frise

luminária

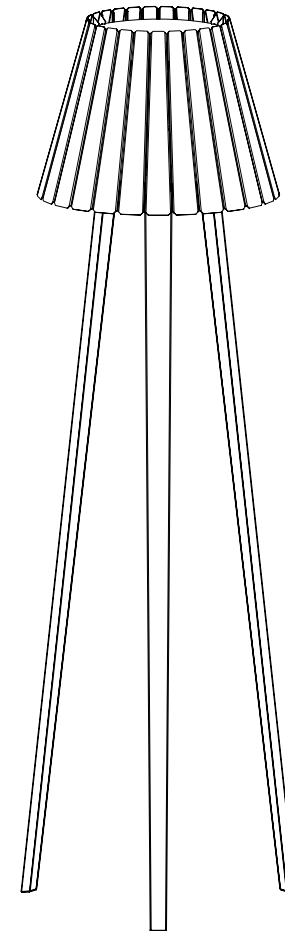

L 44 P 44 A 161

visão
isométrica



coluna plier

luminária

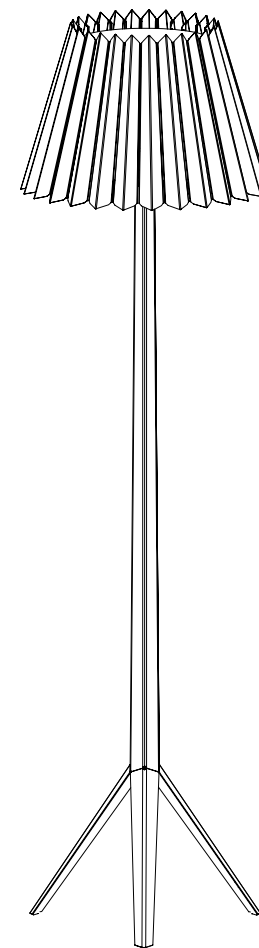

L 44 P 44 A 161

visão
isométrica



pendente frise

luminária

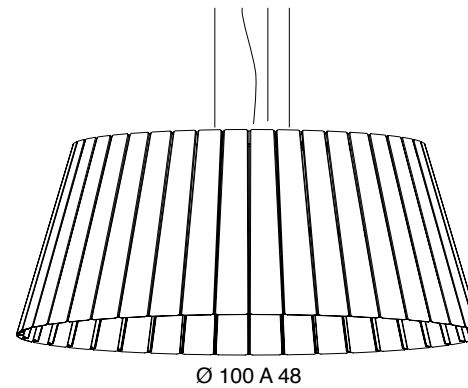

Ø 100 A 48

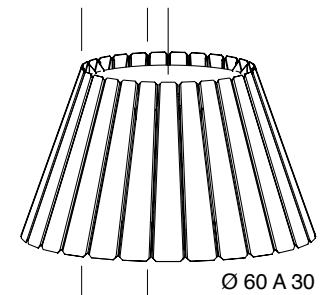

Ø 60 A 30

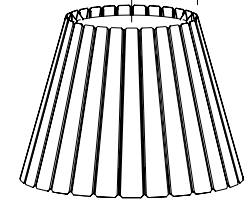

Ø 43,5 A 30

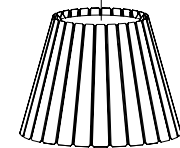

Ø 29 A 20

visão
isométrica



pendente plier

luminária

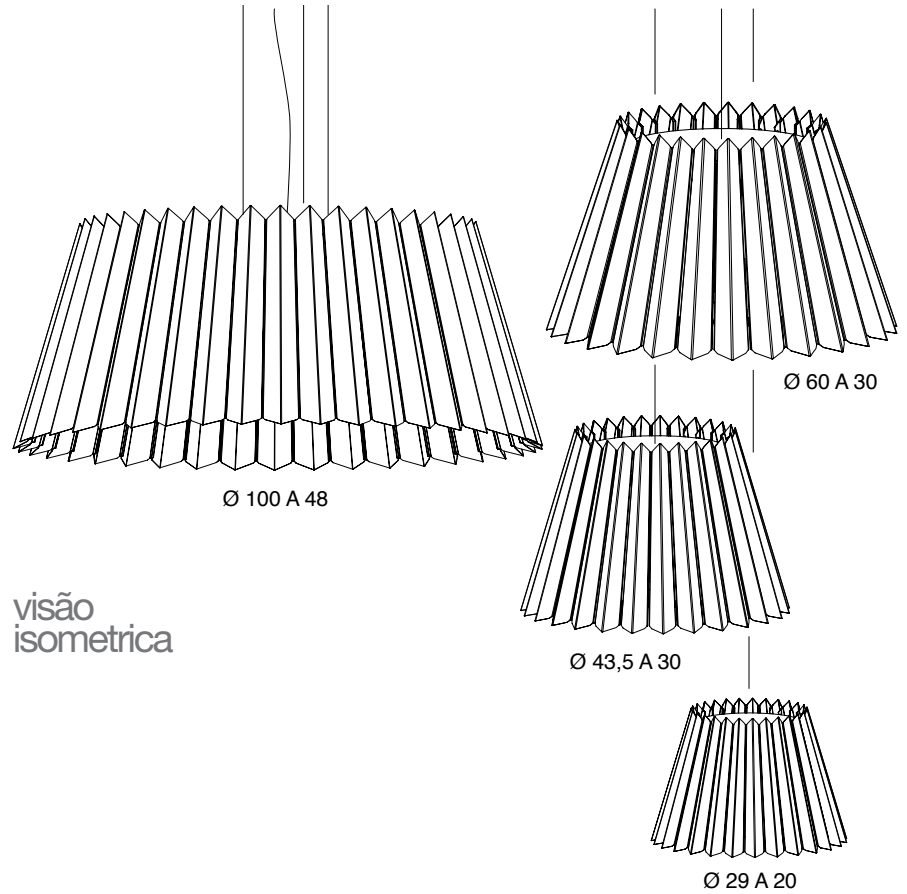

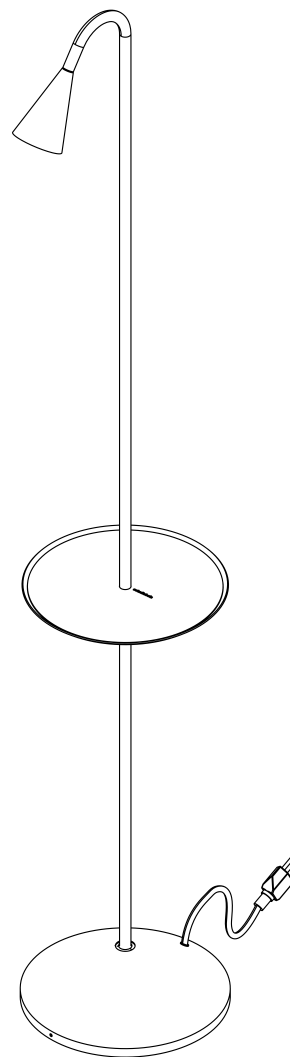

L 23,5 P 23,5 A 139

estudiobola  cerâmica

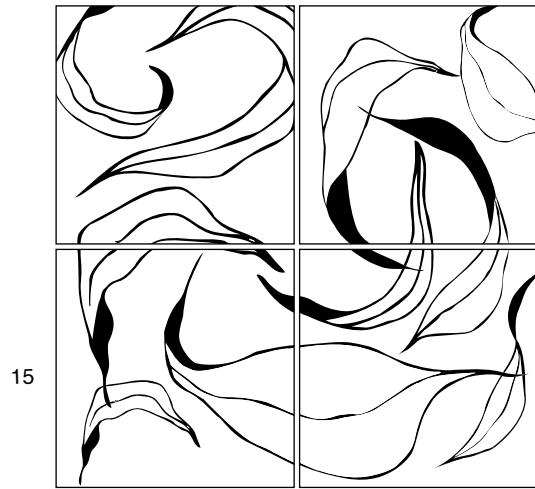

15

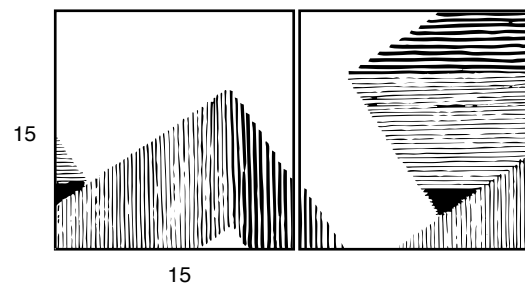
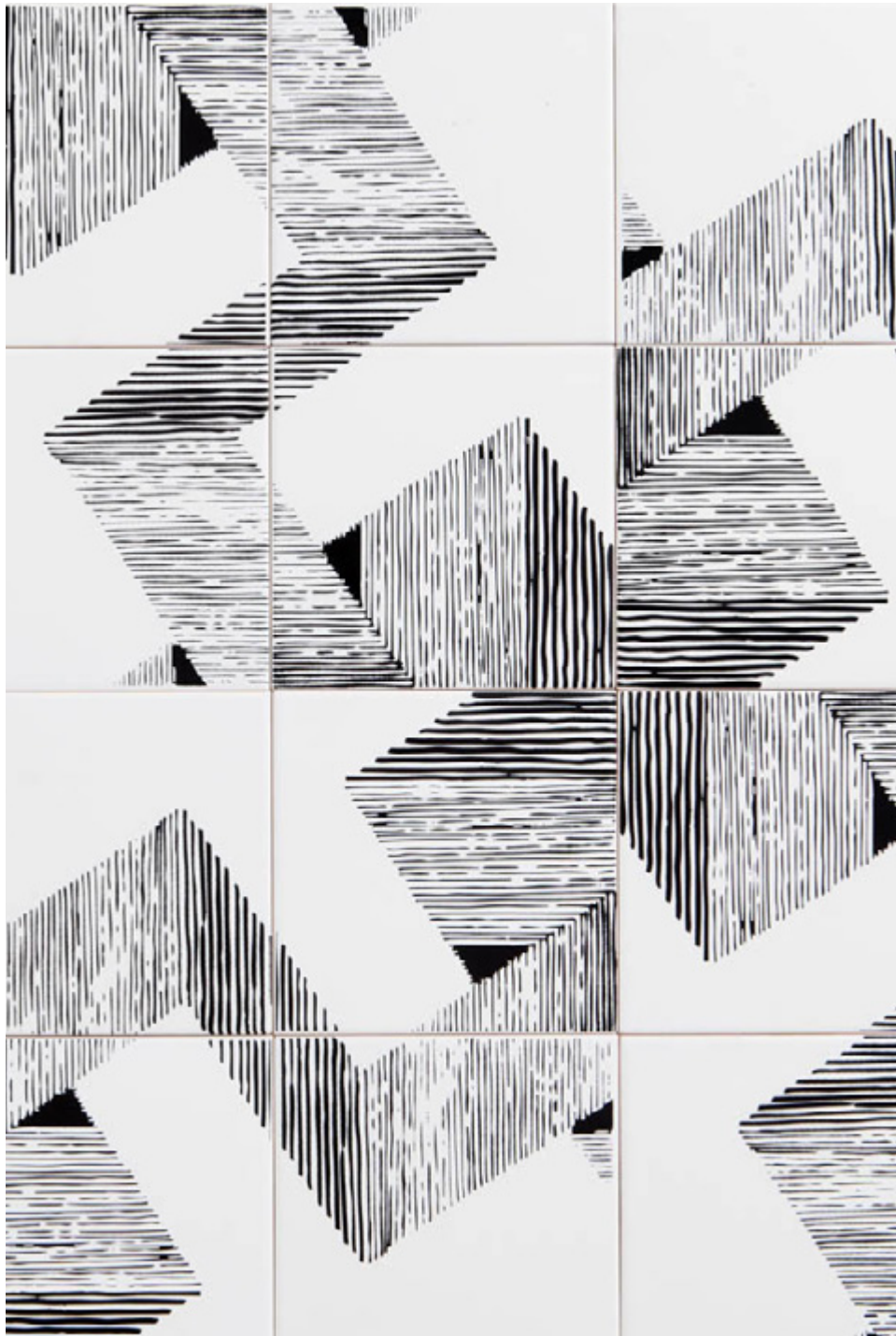

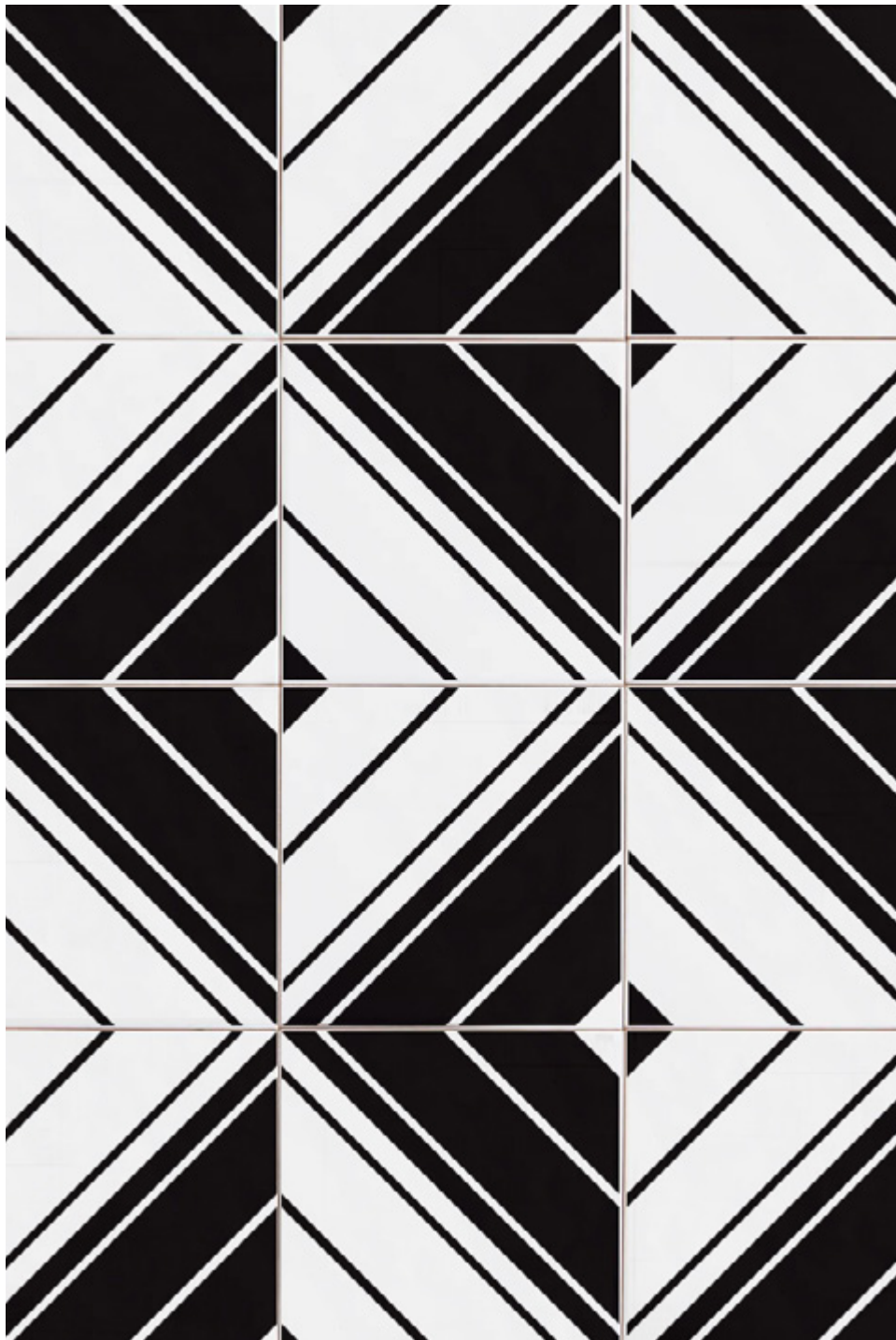

marlboro
cerâmica

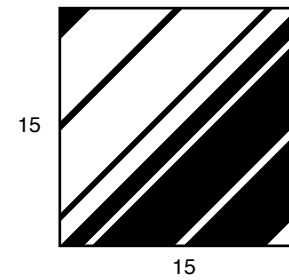

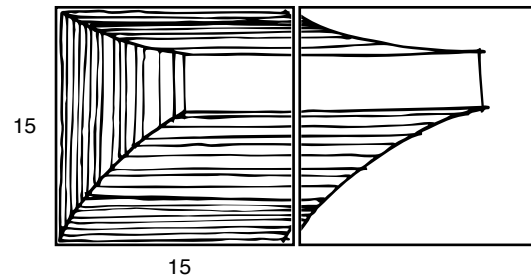
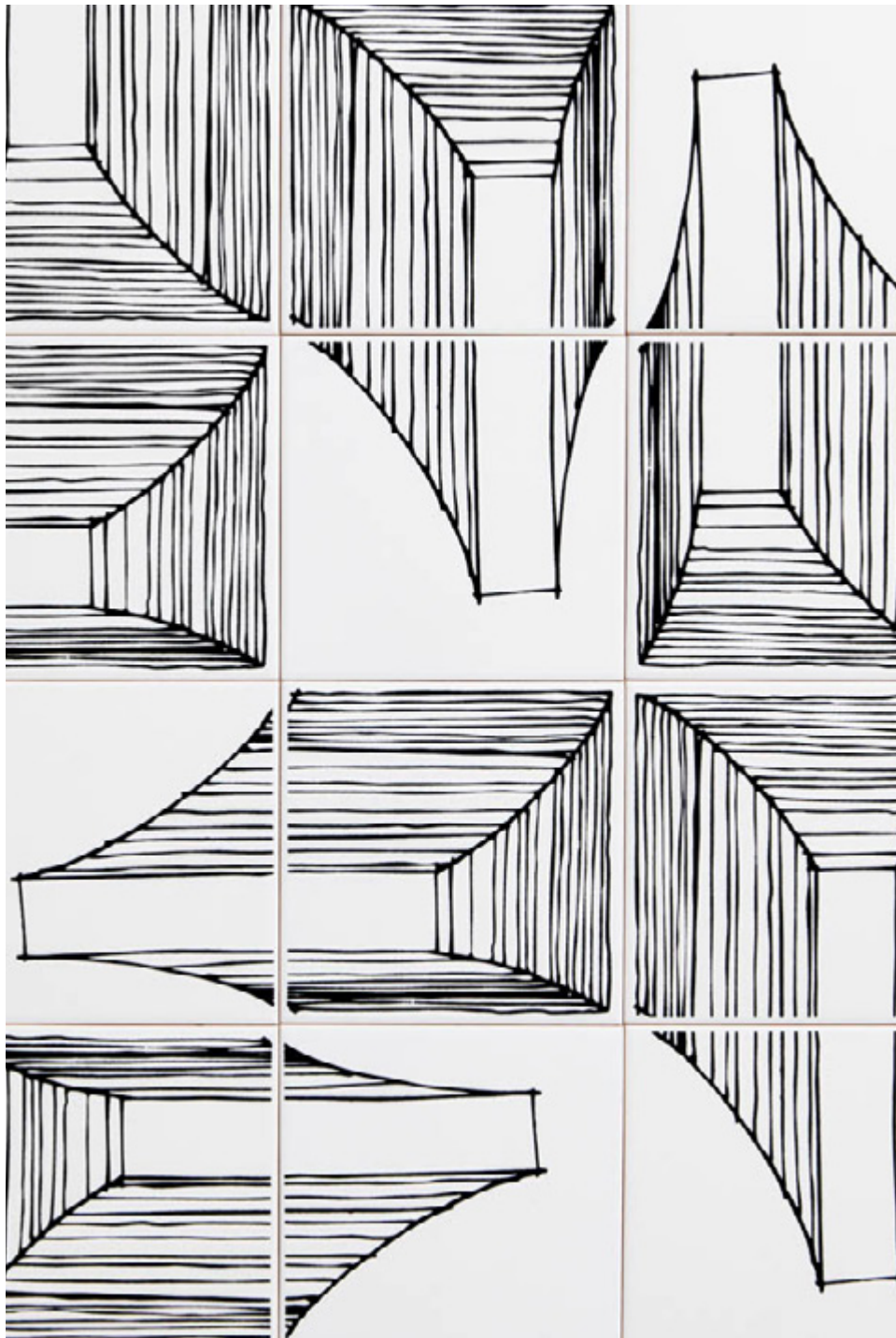

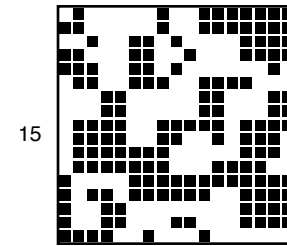
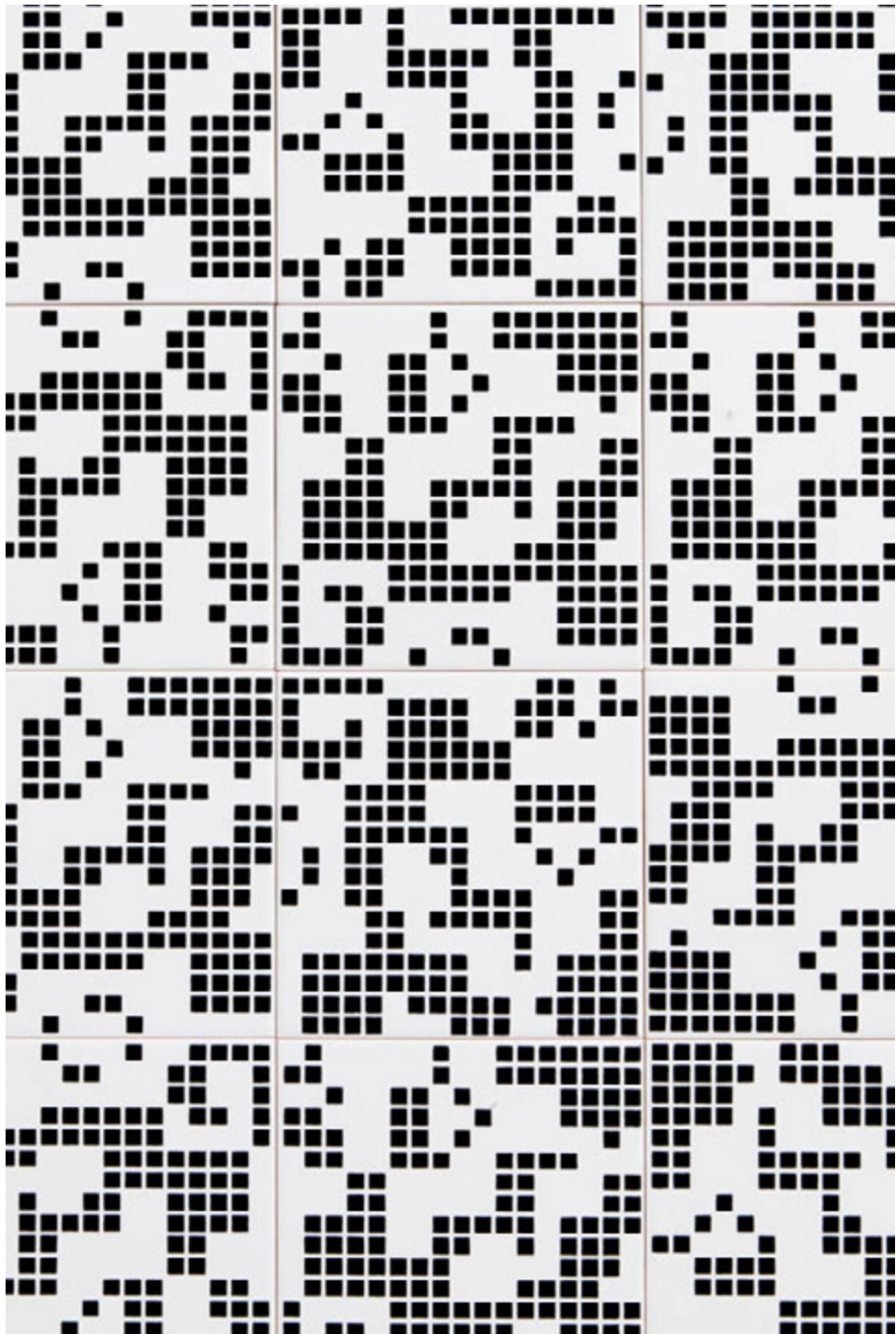

15

15



labirinto
tapete







pixel 2
tapete







natural 1

tapete



natural 2

tapete



natural 3

tapete



natural 4

tapete



sole grosso
tapete



sole fino
tapete



estudiobola  complementos



árdea

complementos

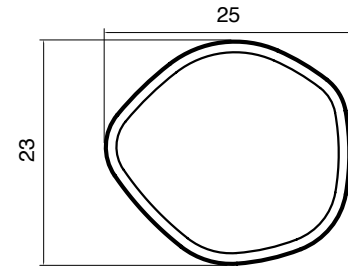

elevação superior

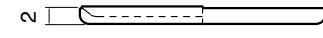

elevação lateral

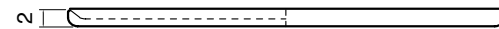
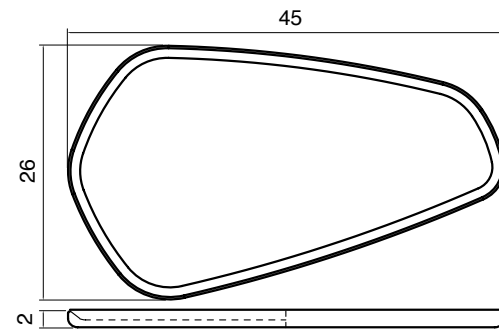
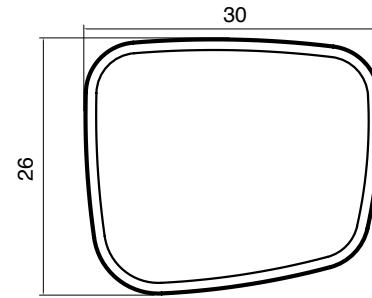

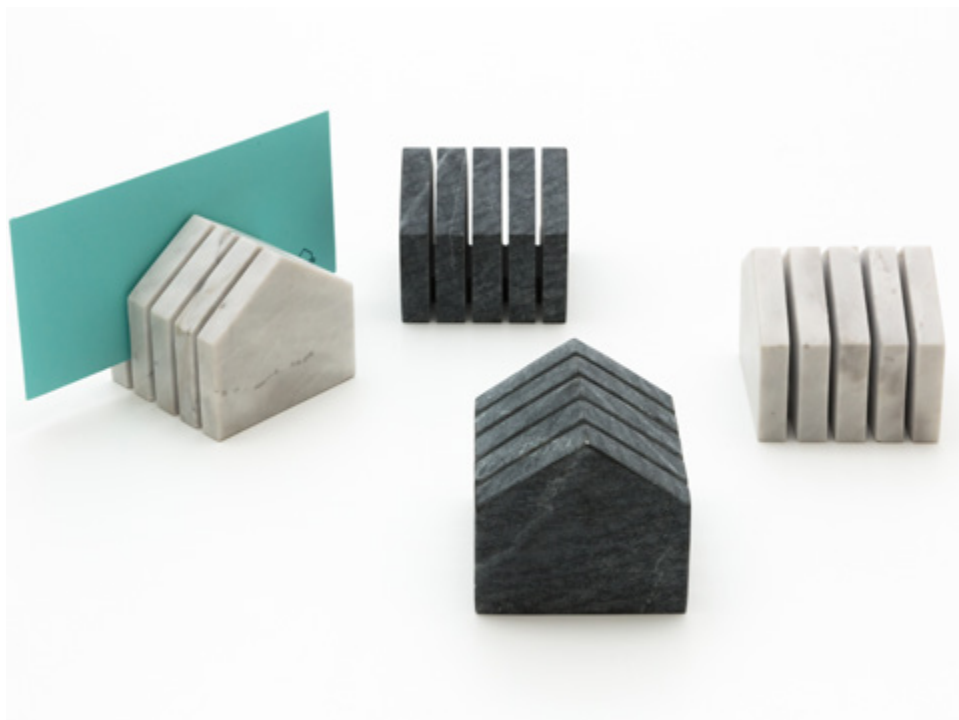

elevação
frontal

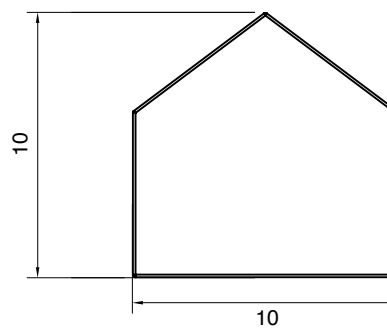

elevação
lateral

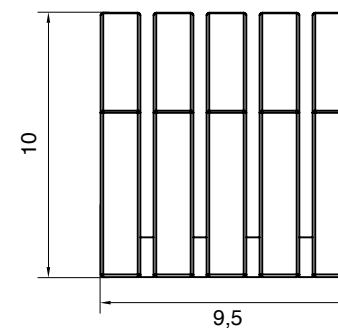

elevação
superior

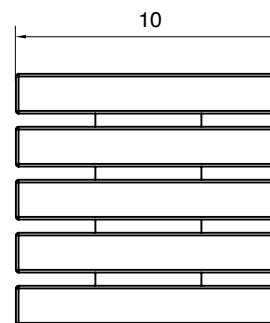



kanô
complementos

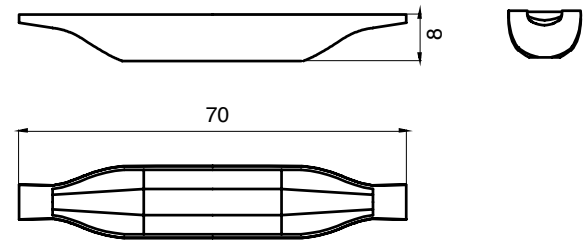
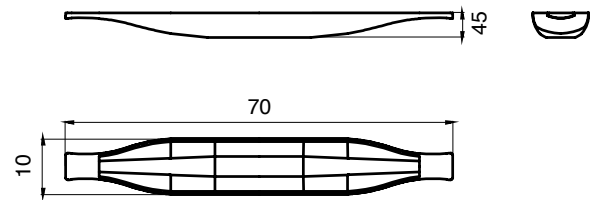
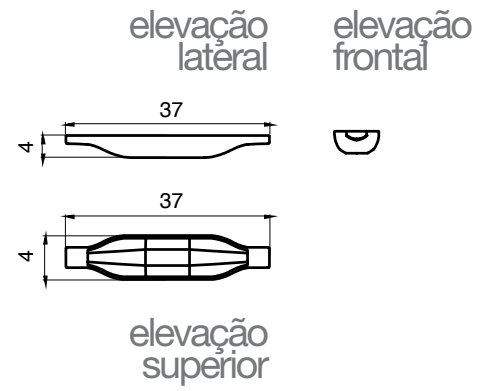



elevação
lateral

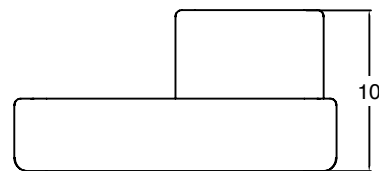

elevação
superior

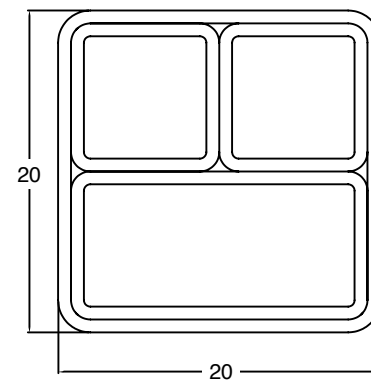



star
complementos

elevação
frontal

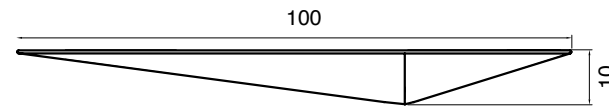

elevação
lateral

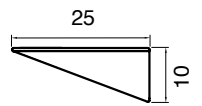

elevação
superior

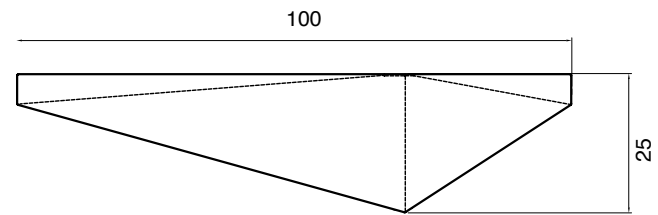



carrinho de boi

complementos

elevação lateral

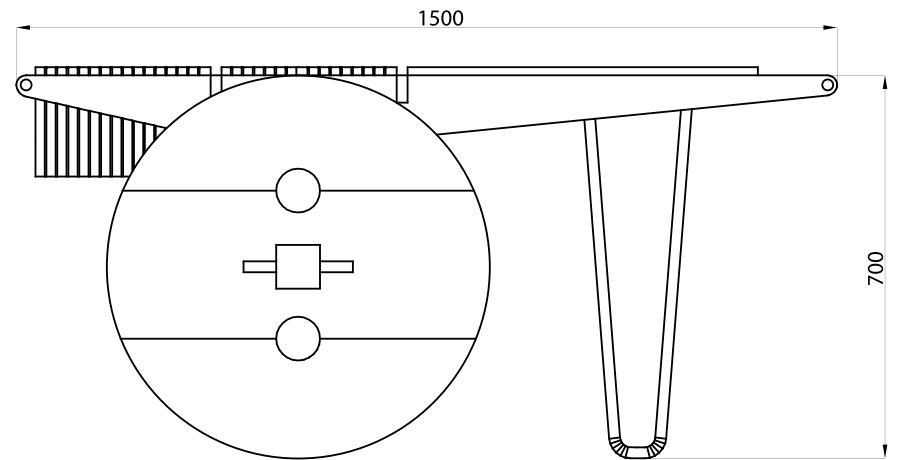

carrinho enzo

complementos



elevação
frontal

45

70

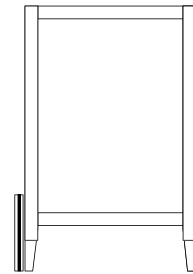

elevação
lateral

89

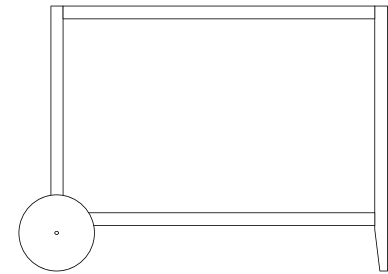

97

• 10 •

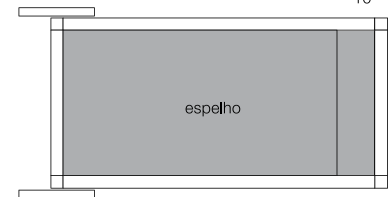

elevação
superior

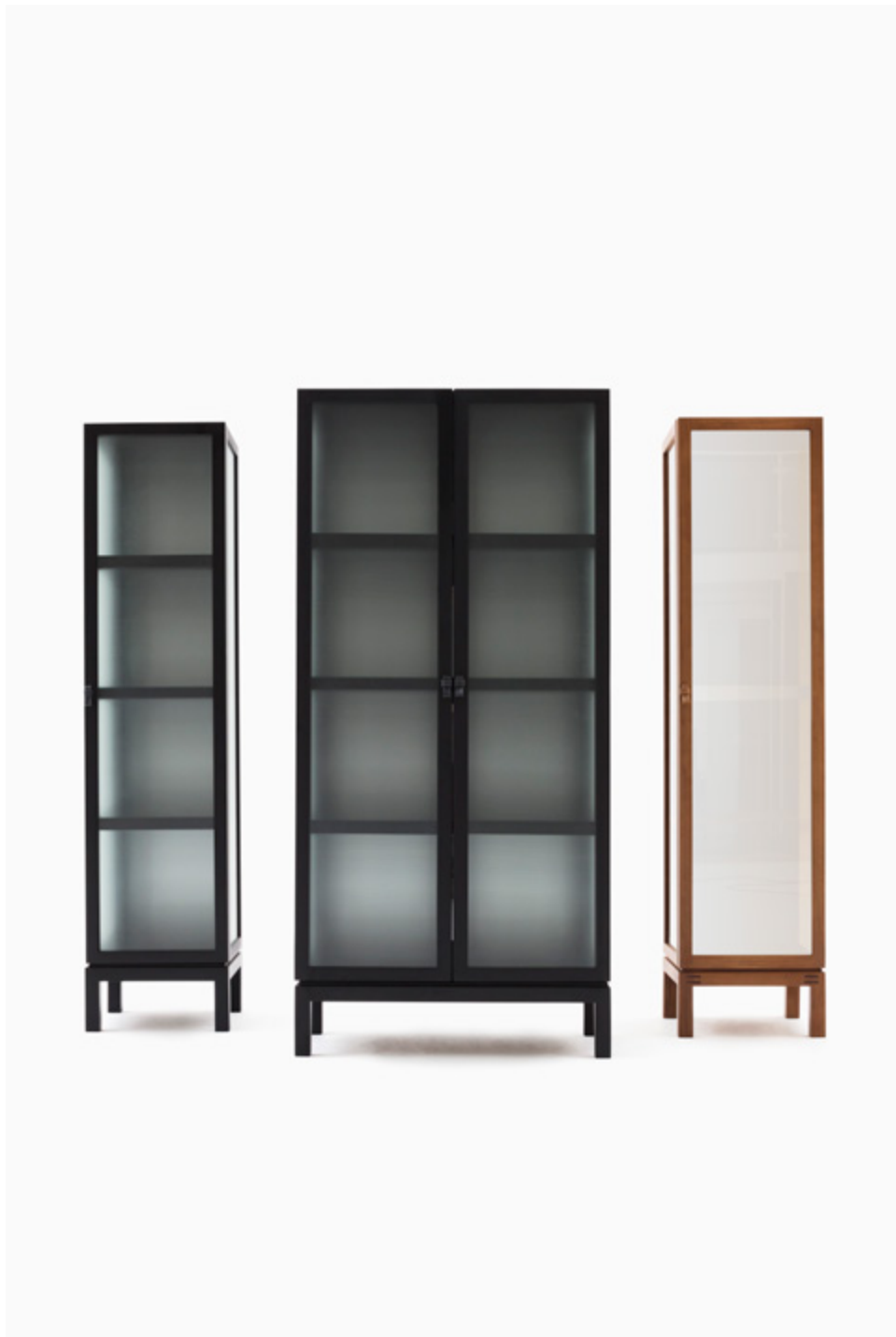

cristaleira grid

complementos

elevação
frontal

elevação
lateral

900

450

1700

1910

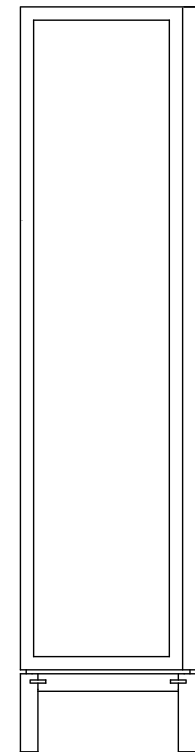
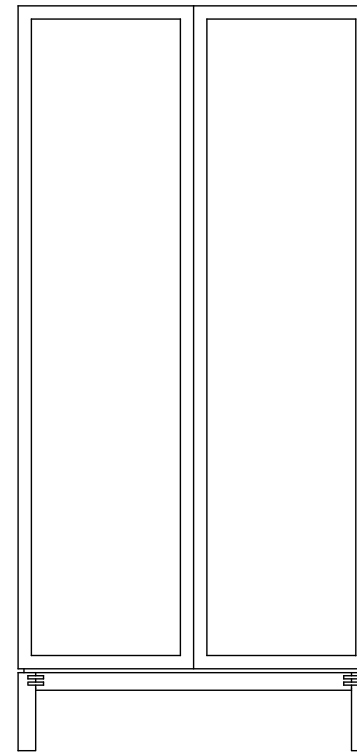



cabideiro balloon

complementos

elevação lateral

148

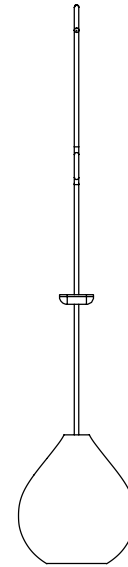

elevação frontal

43

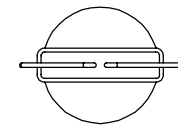
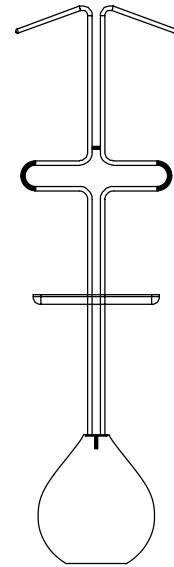

elevação superior

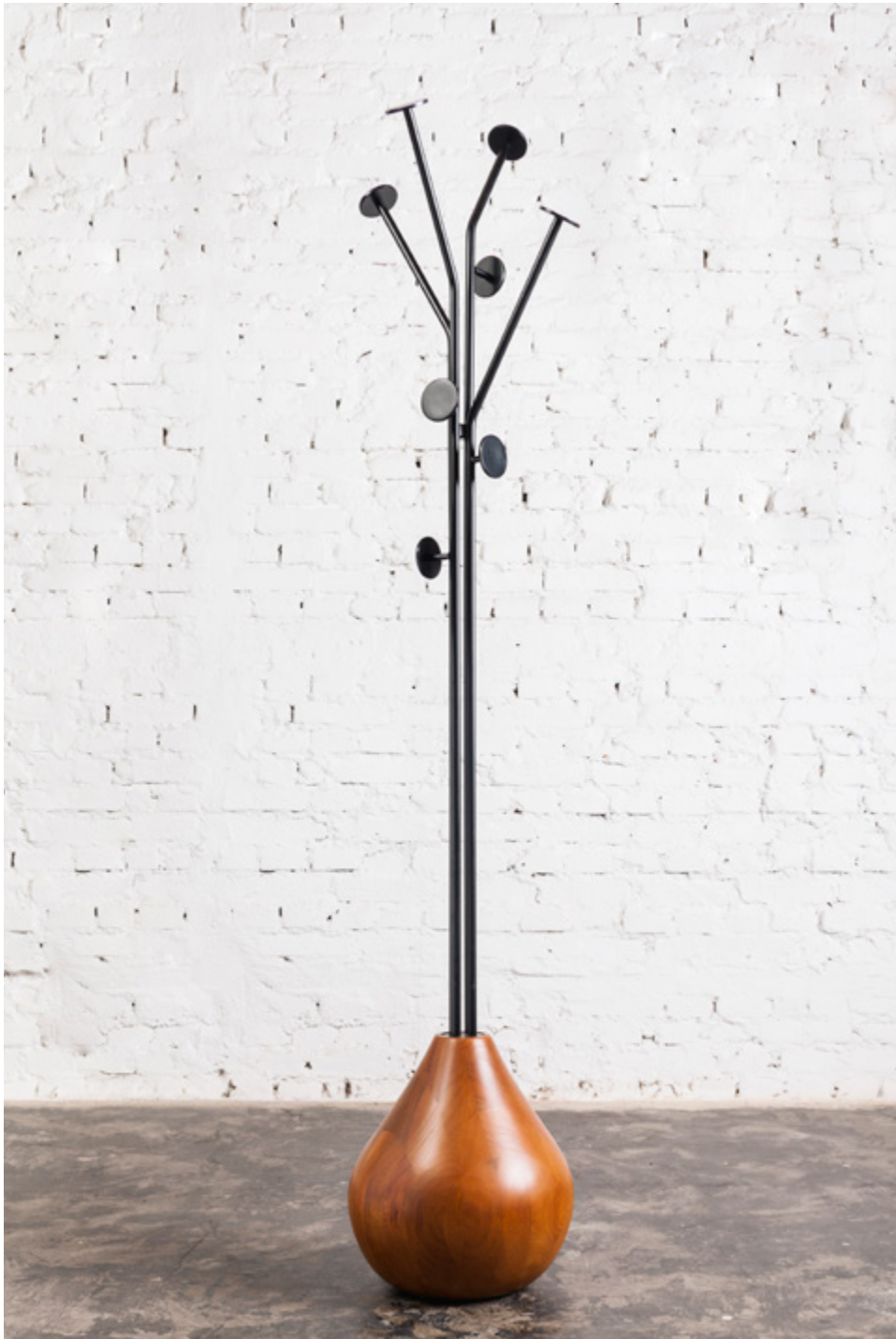

mancebo balloon

complementos

elevação lateral

164

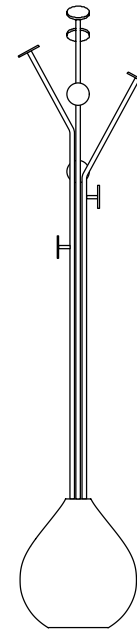

elevação frontal

31

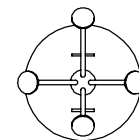
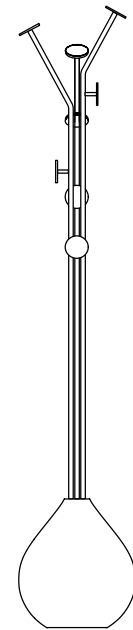

elevação superior



porta guarda-chuva balloon

complementos

elevação
lateral

elevação
frontal

91

31

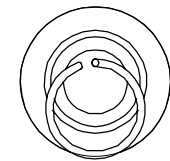
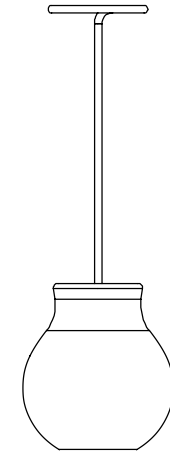
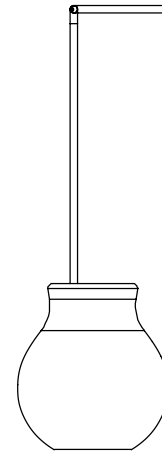

elevação
superior



bandeja viki

complementos

elevação
frontal

40

60

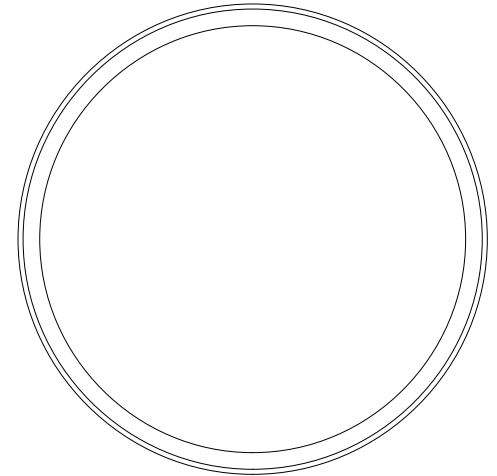
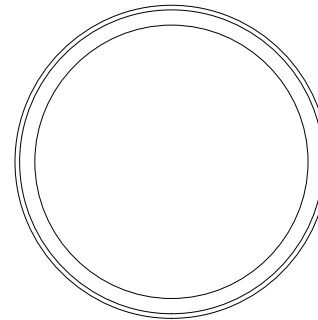

elevação
superior



modular *sofá*

composição divã

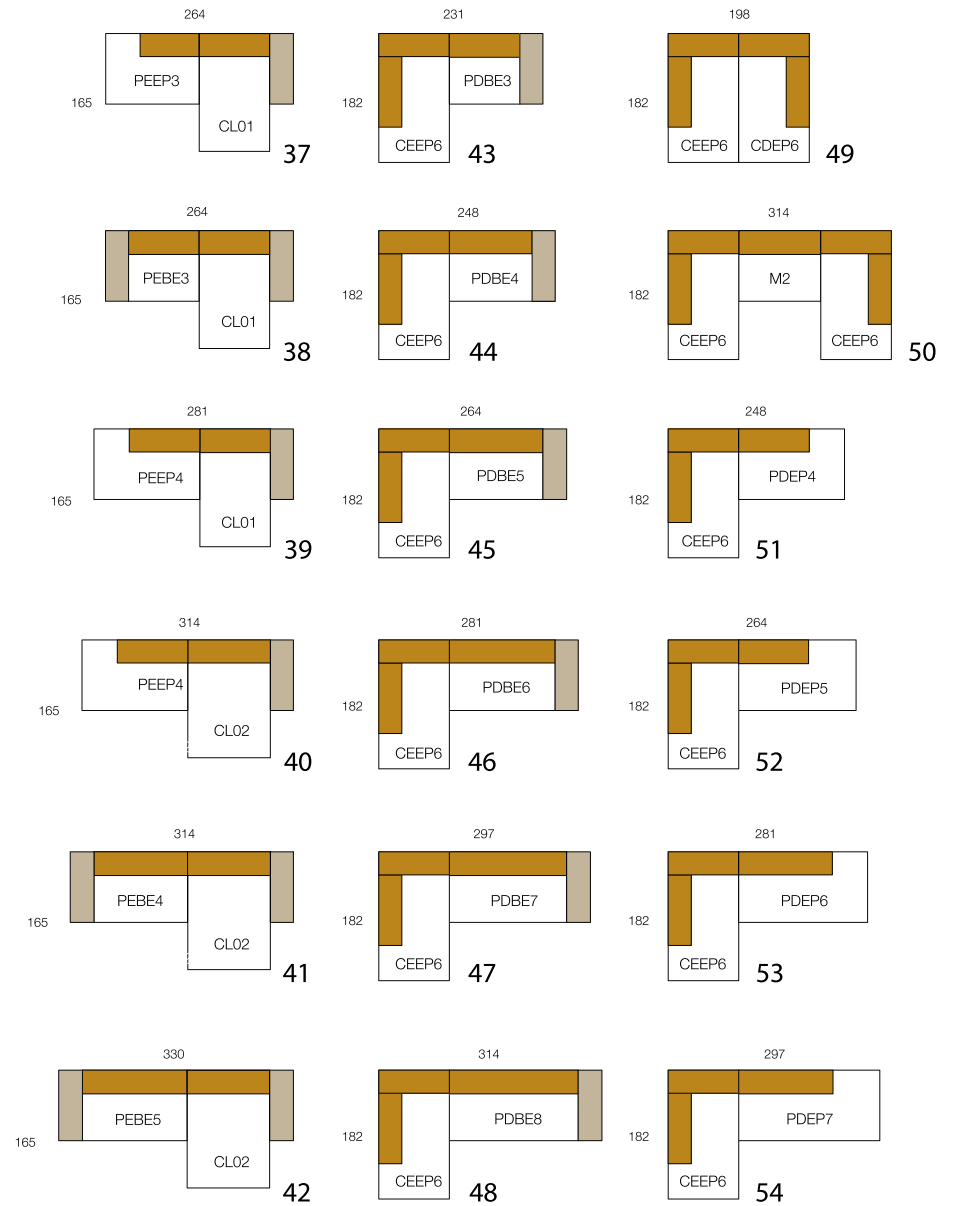

composição linear

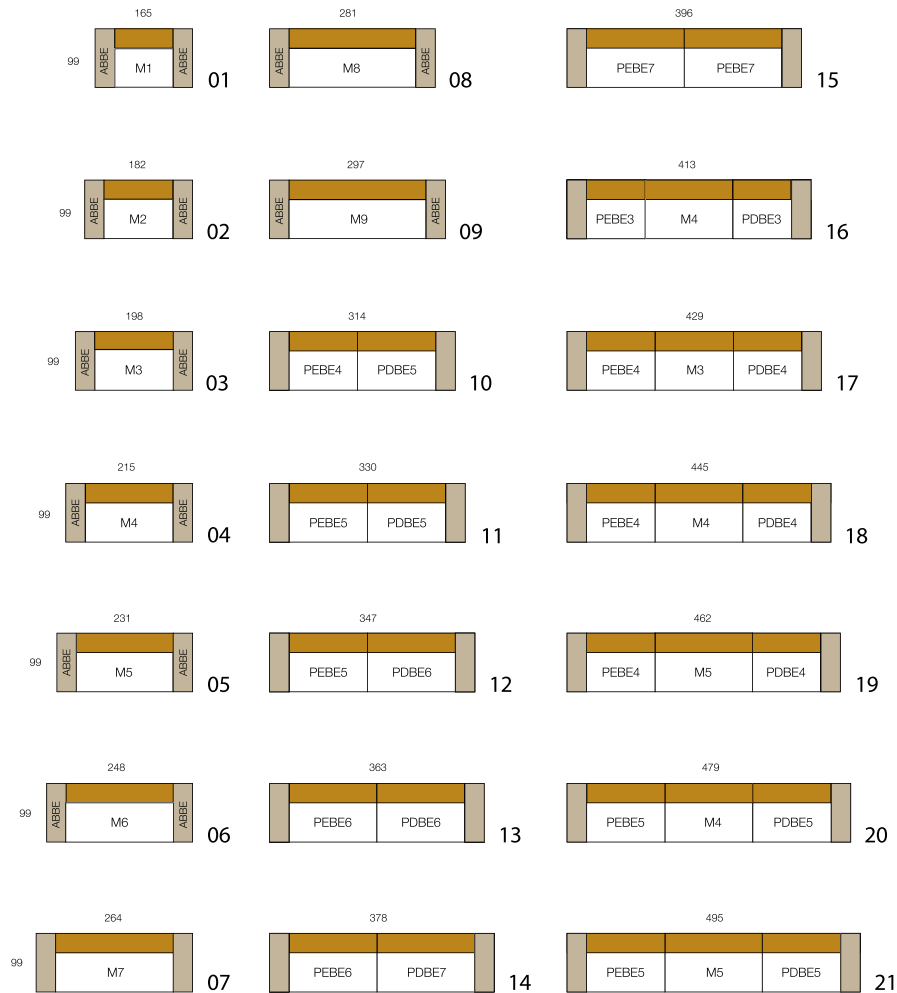

composição canto

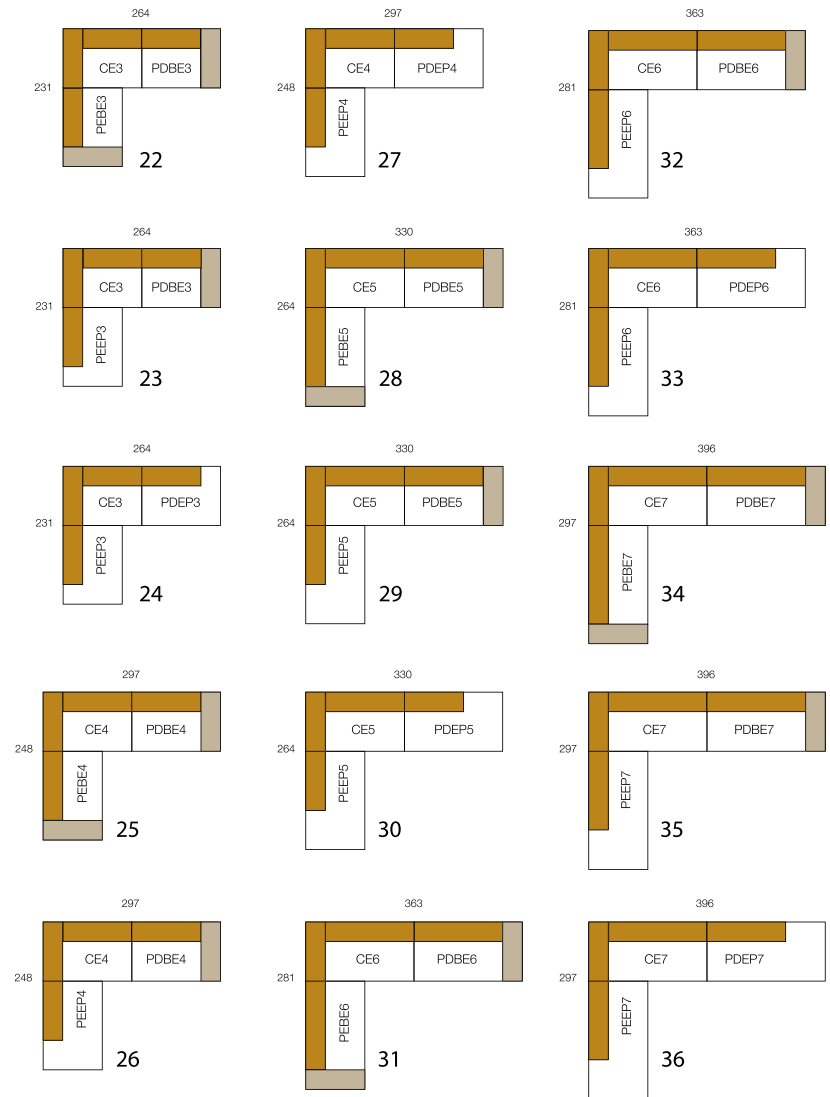

modular

sofá

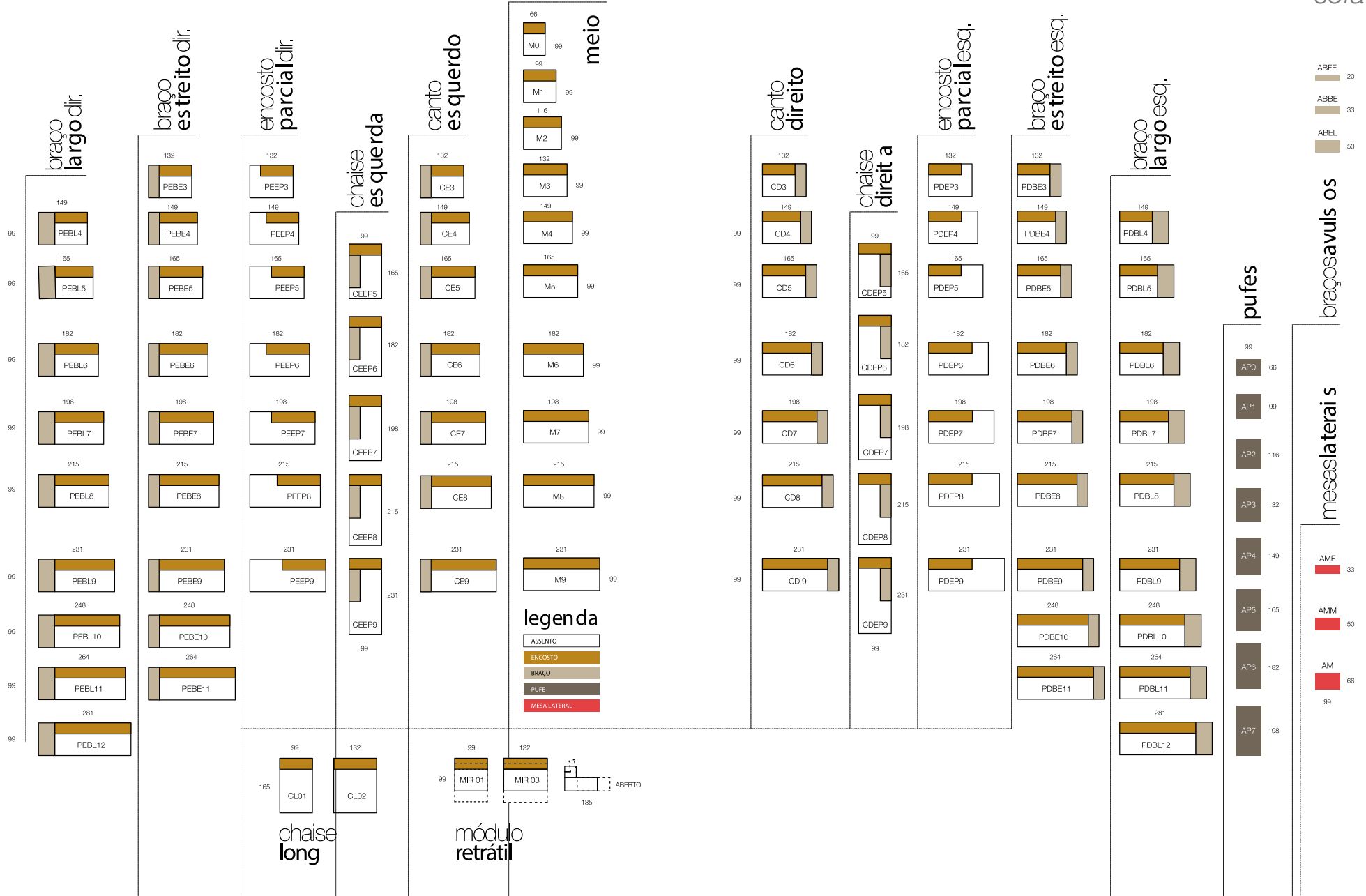



mexerica

área externa

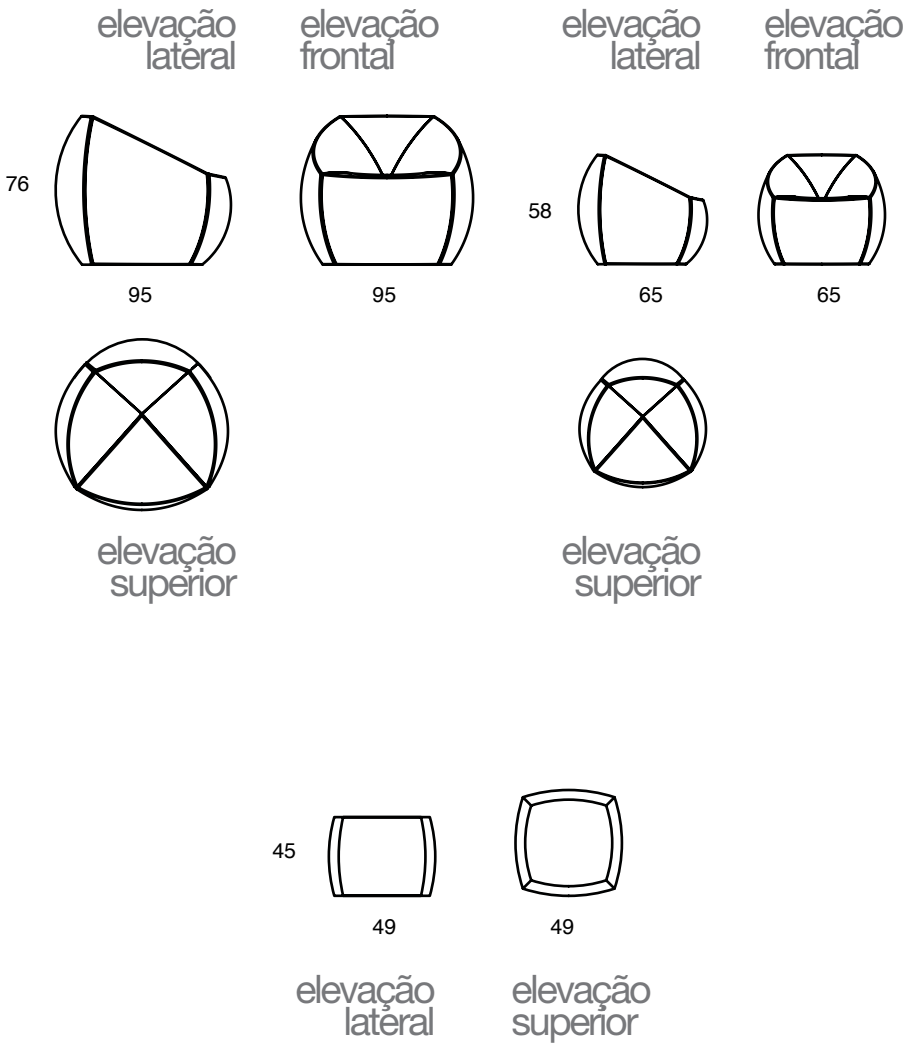



mexerica lounge

área externa

elevação lateral

elevação frontal

156

102

68

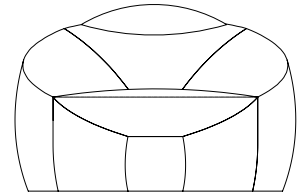
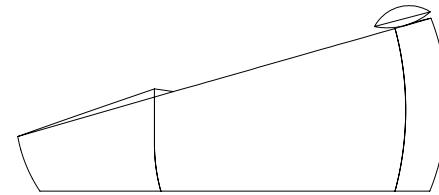

156

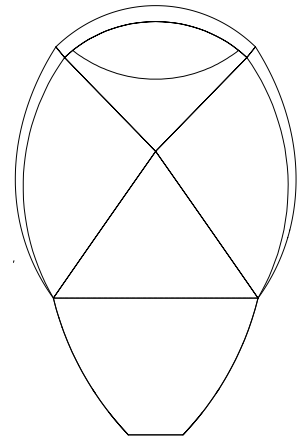

elevação superior



mexerica chaise

área externa

elevação lateral

elevação frontal

168

121

70

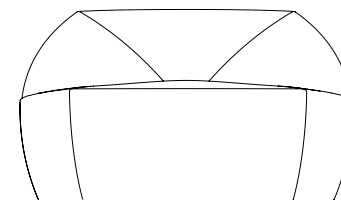
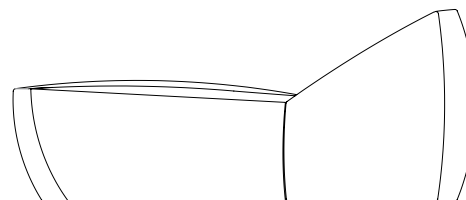

168

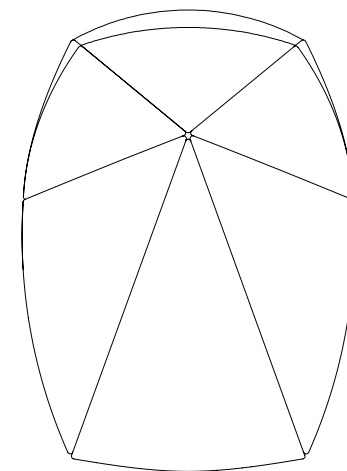

elevação superior



espreguiçadeira bola

área externa

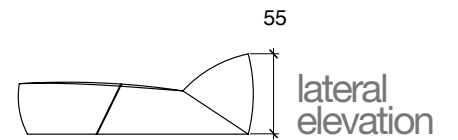
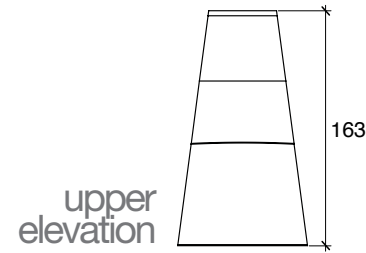
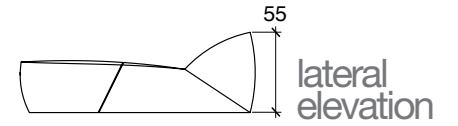
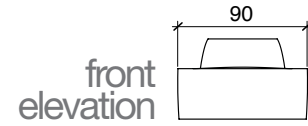

banco ryan

área externa



elevação superior

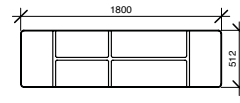
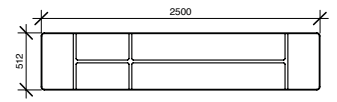
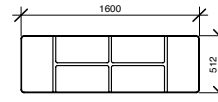
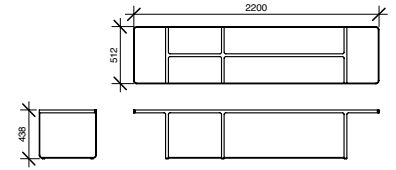
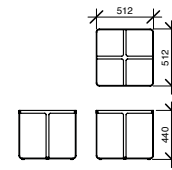

elevação lateral

elevação frontal

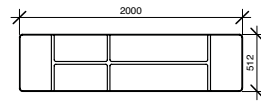



cadeira nolita

área externa

elevação
frontal

elevação
lateral

84



55



58

84



60



60

poltrona nolita

área externa



elevação
frontal

elevação
lateral

72



59

63



banqueta nolita

área externa

elevação
frontal

elevação
lateral

96

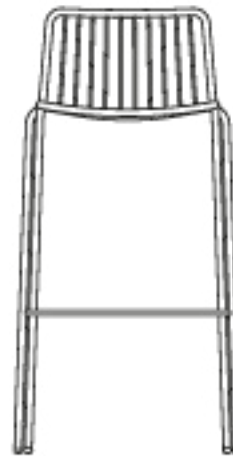

51



49

mesa ypsilon

área externa



elevação lateral



73

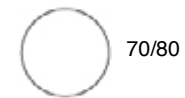

70/80

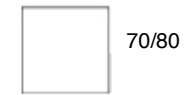

70/80

elevação superior

elevação lateral

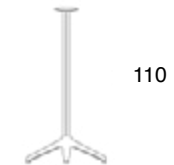

110



60



60

elevação superior



mesa nolita

área externa

elevação lateral



elevação lateral

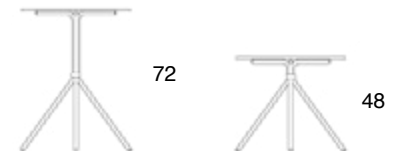

elevação superior



elevação superior

fotos

guilherme gomes
julio menezes
estudiobola
fotos meramente ilustrativas

direitos autorais

direitos reservados do autor (produtos patenteados)
a empresa se reserva o direito de alterar os produtos
sem aviso prévio. favor consultar o representante para
confirmação de disponibilidades.



contato

www.estudiobola.com

end _ rua presidente antônio cândido, 228
alto da lapa _ cep 05083 060
são paulo _ sp _ brasil

adm@estudiobola.com
tel _ 11 3129 8257

end _ rua gaivota, 1466
moema _ cep 04522 073
são paulo _ sp _ brasil

moema@estudiobola.com
tel_11 3774-0192

estudiobola